

# CWB 1858

Wheel balancer

---

## Operation Manual

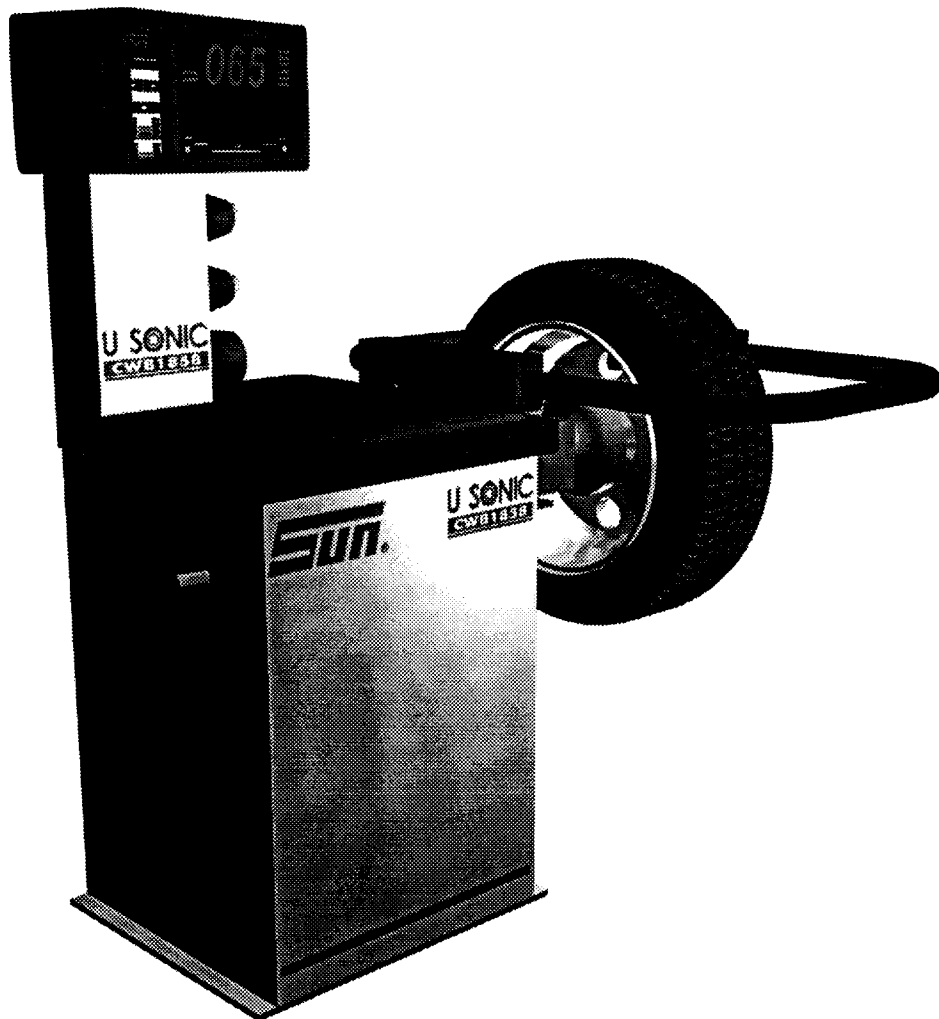

---

"FOR REFERENCE ONLY"

## CONTENTS

Safety Cautions and Warnings .....	ii
Installation and Assembly .....	iii
Installation .....	iii
Assembly Instructions .....	iii
Selection of Ounce/Gram Units .....	iv
Introduction .....	1
Features .....	2
Wheel Mounting Accessories .....	3
Standard Accessories .....	3
Optional Accessories .....	4
Functional Description .....	5
Balancer Display .....	6
Input Panel .....	7
Two-Button Functions .....	8
Offset Scale .....	8
Measuring Frame .....	8
Calipers .....	9
Storage Pegs .....	9
Weight Tray .....	9
Balancing Operation .....	10
Operating Procedure .....	10
Entering Dimensions in Manual Mode .....	13
Balancing Errors .....	14
Weight Modes .....	15
Normal (clip-on) .....	15
Alu 1 .....	15
Alu 2 .....	15
Alu 3 .....	16
Alu 4 .....	16
CTS .....	16
Static .....	16
Special Applications .....	17
Wheel Mounting Methods .....	19
Optimatch: Tire and Rim Matching .....	23
Matching Symbols .....	23
Starting the Matching Procedure .....	24
Starting with Rim only .....	25
Starting with Rim plus Tire .....	27
Calibration .....	31
Weight Calibration Procedure .....	31
Weight Calibration Errors .....	33
Frame Calibration Procedure .....	34
Frame Calibration Errors .....	35
Service and Maintenance .....	36
Operational Check .....	36
Troubleshooting Guide .....	39
Technical Specifications .....	43

## SAFTEY CAUTIONS AND WARNINGS

1. Read the Operators Manual before operating the balancer for the first time. Follow all instructions and warnings marked on the product.
2. The balancer operates from a 110 Vac, 60 Hz power source. Do NOT use any other voltage/frequency electrical outlets. Use only an EARTHED electrical power source. Use only a correctly rated replacement fuse.
3. Arrange the power cord so that it will not be tripped over or pulled, and keep it clear of moving parts. If an extension cord is used, ensure its current rating equals that of the power cord supplied. Immediately replace a damaged power cord.
4. Ensure the balancer rests on all three feet on a clean, level floor with no debris under the base.
5. Do not operate the balancer; a) near fumes or exposed flammable liquids; b) on wet surfaces. Do not expose the balancer to rain.
6. Adopt the correct lifting procedures when lifting any object. Weights in excess of 100lb (45kg) should not be lifted unaided.
7. NEVER remove a cover or access panel on the balancer without first disconnecting the balancer from the electrical power source.
8. Only authorised and trained operators should use the machine.
9. Wear approved eye protection when removing or attaching weights. Keep hair, clothing and all parts of the body clear of balancer moving parts.
10. Remove all stones, old weights, and other debris from the wheel before balancing.
11. Center and tighten the wheel on the shaft before spinning the wheel.
12. Check that all wheel weights are properly applied and secured.
13. The balancer will return to the normal power-up state if the power is interrupted.
14. When the balancer is not in use, disconnect the power cord and use the available pegs and trays for storage of accessories.

## CWB 1858 INSTALLATION & ASSEMBLY

Your CWB 1858 Wheel Balancer and accessories will be delivered in a single carton mounted on a pallet.

### Installation

- A. Unpack the balancer and all accessories.
- B. Check the contents list below and confirm that all parts are present. Check also for the standard wheel mounting accessories and any optional accessories you may have ordered.

<u>Qty</u>	<u>Item</u>
1	Base unit.
1	Display unit.
1	Display support & backpanel.
1	Frame (measuring).
1	Power cord.
1	Set of wheel mounting accessories.
1	Rim width Calipers.
2	Set of weight tray labels.
1	Operators manual.

- C. Place the base unit on a firm solid floor.
- D. Read the *Assembly Instructions* section.

### Assembly Instructions

*Tools required : 0.40" and ½" open end wrench  
Phillips screwdriver.*

1. Remove the *weight tray* by unscrewing the two *Phillips screws*, and then lifting up the *tray* from the *base*, separating it from the *velcro fasteners*.
2. Slide the *display support* into the slots in the machine base, and attach the *M6 bolt and washer* at the side of the *base*. Locate the *display unit* on the *support*, making sure that the cable is on the inside of the *display support*. Slide in the *support backpanel* and attach the four *M6 bolts and washers* into the *backpanel*.

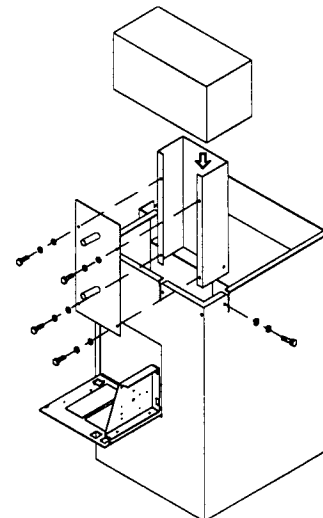
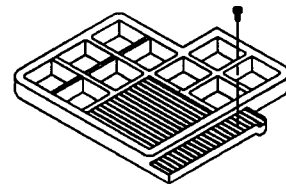

3. Attach the *measuring frame* using the four *nuts and washers* on the *pivot bar*. Connect the *frame cable* and *cable bracket* to the bottom of the *PCB door*.

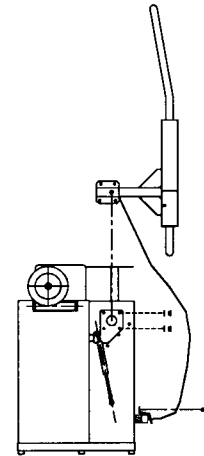

4. Attach the *display cable (2-way)* to the *PCB door* as shown.
5. Re-assemble the *weight tray* by attaching it using the *velcro fasteners* and *screws*.
6. Attach the *PCB door* to the *rear of the base* using the two screws provided.

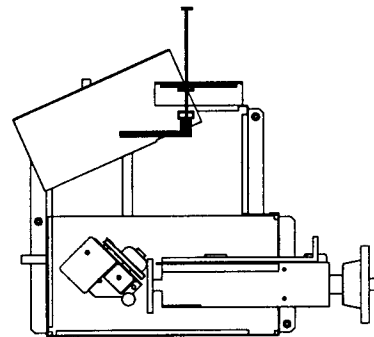

7. Fix the *stub shaft* to the *spindle*, by inserting the *bolt* and *tightening* to a torque of 110-130lbs.
8. Verify the correct voltage is shown on the product serial label. Connect *balancer* to the *mains outlet* using the *power cord* provided. Switch on the *wheel balancer*.

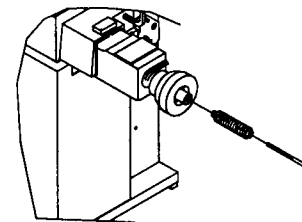

**Your balancer is now ready for use!**

### Selection of Ounce/Gram Units

The balancer is programmed before leaving the factory to display weight imbalance in ounces. To change this setting to gram units, press the *Left Arrow* button and *Match* button together for a few seconds, until a decimal point disappears in the display (000). Repeating these steps will change the units back to ounces (0.00).

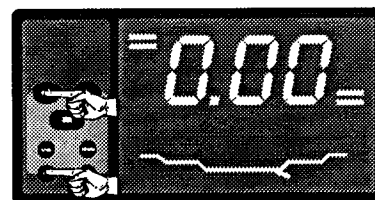

## INTRODUCTION

The SUN CWB 1858 Automatic Wheel Balancer combines advanced, high-performance technology, robustness, reliability and simplicity of operation.

The features of the CWB 1858 cater for a variety of wheel service facilities. It is designed for use under a wide range of conditions, and will maintain perfect operation under the most demanding usage.

Low-speed rotation of the wheel by either hand-spinning or by the low-power motor, ensure that the CWB 1858 is one of the safest machines currently in the market.

**An Automatic Wheel Measurement System** employing ultrasonic sensors to scan the dimensions of the wheel means that **no input is required from the user. Balancing is simply a matter of mounting the wheel and lowering the frame.**

The CWB 1858 features an easy-to-use Display and Input Panel, ensuring quick and intuitive operation. Operator time and effort are reduced to a minimum, without compromising wheel balancing accuracy and repeatability.

Take a few minutes to study this manual and become acquainted with the features and capabilities of your new CWB 1858 Wheel Balancer before operating the balancer for the first time.

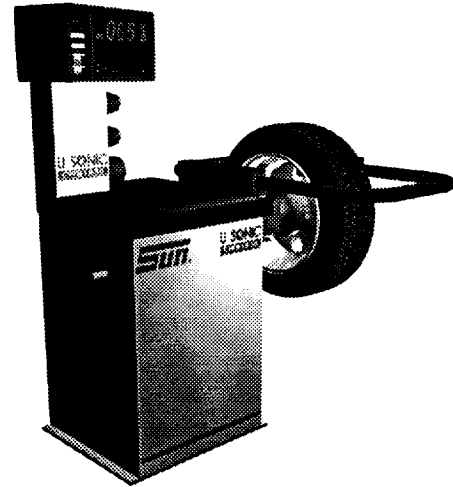

## FEATURES

The SUN CWB 1858 Automatic Wheel Balancer applies the latest technology in wheel balancing for automobile and light truck wheels in an economical and powerful package which includes these features:

- Dynamic (twin-plane) and Static (single- plane) balancing.
- Single-spin cycle (7 seconds).
- Choice of 8 weight location modes :  
Normal, Alu 1, Alu 2, Alu 3, Alu 4, CTS, Static Special.
- Quick and easy entry of wheel dimensions using Automatic or Manual input system (rim diameter, rim width and offset).
- Weight position indicators show exact positions of weights for all balance modes.
- Automatic recalculation of results for changes in wheel dimensions or modes without respinning the wheel.
- Fine mode increases accuracy to within 0.10 ounces (2 grams).
- Ounces or Grams weight units.
- Inches or Millimeters wheel diameter units.
- Optimatch Tire and Rim Matching programme.
- Low-speed balancing and automatic brake for maximum operator safety and equipment protection.
- Automatic self-calibration.
- SPECIAL balancing mode specifying exact weight locations by manually programming an inner and outer rim diameter.
- Low-power motor for minimum power consumption and increased reliability.
- Weight trays and pegs located for convenient storage of weights, cones, springs and other accessories.
- Range of wheel mounting accessories.
- Low service and maintenance costs.
- Bolt-to-floor option.

## WHEEL MOUNTING ACCESSORIES

### Standard Accessories

Quick-Release Hub Nut (P/N 4801-1003)



Cone Spring (P/N WB1131)



Spacer Ring (P/N 8040)



Large Cone (P/N WB1090-01)



Medium Cone (P/N WB1090-02)



Small Cone (P/N WB1090-03)



Extra Small Cone (P/N WB1090-04)



Large Drum (P/N WB1140-01)

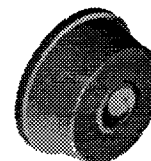

Small Drum (P/N WB1140-02)





**Standard Accessories (cont)**

Large Gasket (P/N WB2533-01)



Small Gasket (P/N WB2533-02)



Stub Shaft (P/N 8322)



Light Truck Cone (P/N WB1133-01)



Extension Adaptor (1") (P/N WB1207-01)



Calipers (P/N WB1158-02)



## Optional Accessories

Universal Wheel Adaptor : (P/N WB1230)

Fits 3,4,5,6,8 and 10-hole patterns. Used on wheels with untrue center holes, and wheels with closed center.



Metric Bolt Plate Adaptor : (P/N WB1499)

Used instead of Universal Wheel Adaptor for wheels with untrue centers or closed centers.



Extra Wide Extension Adaptor : (P/N WB1207-02)

Used for some light truck wheels, reverse offset wheels and any application where wheel must be moved away from machine.



**Additional adaptors and accessories for a variety of wheel mounting applications are available (for example, a motorcycle wheel adaptor kit).**

## FUNCTIONAL DESCRIPTION

The accompanying illustration shows a view from the front of the complete assembled CWB 1858 Wheel Balancer.

1. Input Panel
2. Display Panel
3. Storage Pegs
4. Offset Scale
5. Ultrasonics Measuring Frame
6. Stub Shaft
7. Flange
8. Calliper Peg
9. Weight Tray

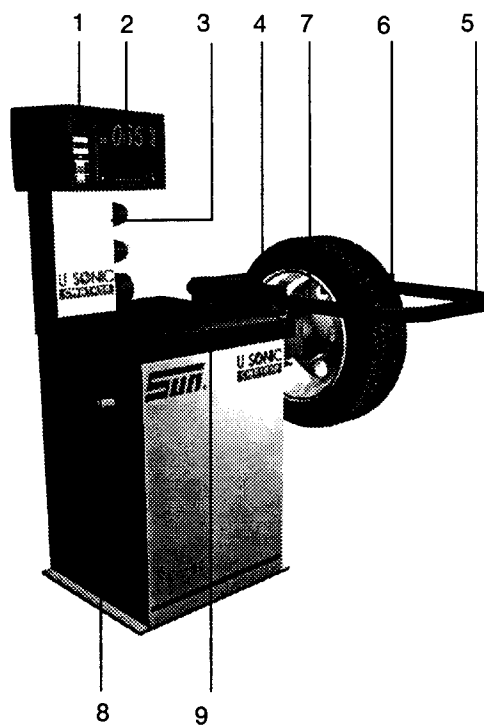

## Balancer Display

The display combines solid-state electronics and graphical design to provide powerful visual presentation and durability.

The display indicates the amount and position of weights, wheel dimensions, operating modes and error conditions.

### 1. Numeric Display

Displays weights in ounces or grams after a spin cycle, when the wheel is rotated to the inner or outer Top-Dead-Center position.

Displays wheel dimensions (diameter, width, offset) in inches or millimeters during wheel data entry.

Displays 'Exx' to report an error.

### 2a. Decimal Point

Used to display weights and wheel dimension values.

### 2b. Ounce indicator

Illuminated constantly when ounces are selected as weight units.

### 3. Weight Position Indicators

Illuminated sequentially as the wheel is rotated. All the indicators on one side are illuminated when the correct position for attaching the weight at Top-Dead-Center (TDC) is reached. This applies to both inner (3a) and outer (3b) weight positions.

### 4. Rim Profile

Graphical rim profile to illustrate the Weight Mode in operation.

### 5. Weight Mode Indicators

Illuminated Clip-on Weight (green, circular) and Stick-on Weight (yellow, rectangular) indicators to correspond to the Weight Mode selected.

### 6. Mode Indicators

These indicate specific operating states:

- 6a. Standard/Fine accuracy
- 6b. Automatic/Manual wheel dimensions
- 6c. Matching indicator.

### 7. MM Indicator

Illuminated constantly when millimeters are selected as rim diameter units.

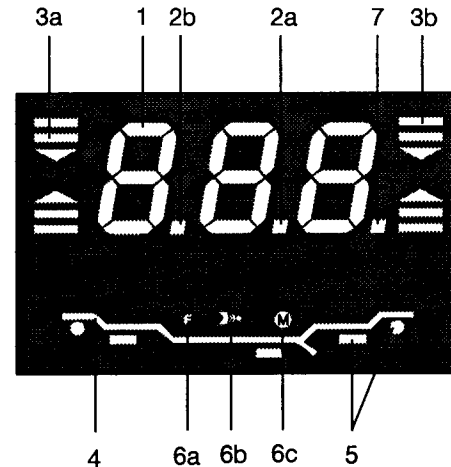

## Input Panel

The input panel contains controls, positioned for convenience, with graphical symbols clearly defining each function.

The input panel is used to select specific operating states and to enter data for the wheel to be balanced and the weights to be used.

### 1. Fine

Used in any mode to balance a wheel to within 0.10 ounces/2 grams (rather than the normal 0.25 ounces/ 5 grams).

### 2. Mode

Selects the Weight Mode. The mode selected is indicated by the weight mode indicators on the rim profile in the display panel. The balancer automatically recalculates the weights and positions for balancing the wheel when a new weight mode is selected without the need to re-spin the wheel.

### 3. Match

Used to start the Optimatch (Tire and Rim Matching) programme. Press Mode to exit the Optimatch programme.

### 4. Auto

This selects Automatic Dimensions mode. Press again to return to Manual Dimensions.

### 5. Left Arrow

### 6. Right Arrow

### 7. Enter

These are used to program dimensions manually and to select Two-Button functions.

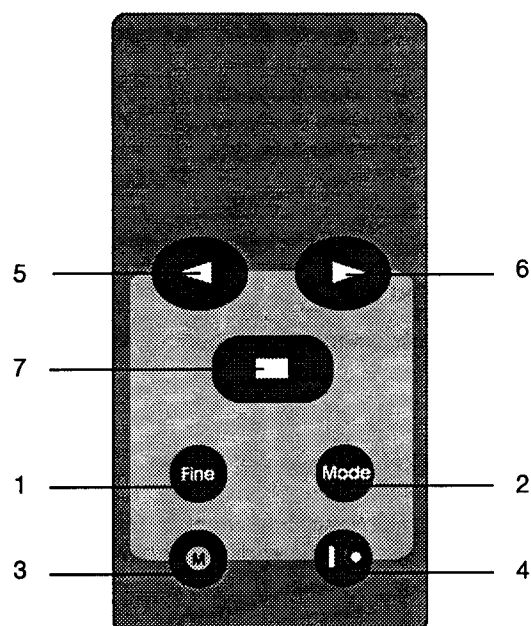

## TWO-BUTTON FUNCTIONS

Press and hold both buttons together for 1 second:

### *Left Arrow + Right Arrow (5 + 6)*

Changes wheel diameter units from inches to millimeters or vice-versa.

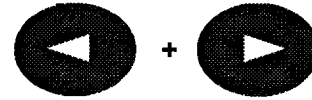

### *Left Arrow + Match (5 + 3)*

Changes weight units from ounces to grams or vice-versa.



### *Left Arrow + Auto (5 + 4)*

Start Automatic Dimensions (Frame) Calibration programme.



### *Left Arrow + Fine (5 + 1)*

Start Automatic Weight Calibration programme.



### *Right Arrow + Match (6 + 3)*

Used to enable or disable Matching Recommended indication.



## Measuring Frame

In Automatic mode, the rim diameter, rim width and rim offset are measured and programmed automatically when the measuring frame is lowered. Lowering the measuring frame also activates the motor and spins the wheel up to measuring speed. When the wheel reaches measuring speed, the motor disengages. The frame is raised after the measuring cycle is completed, when the brake has been automatically applied. If the frame is raised before the measuring cycle is completed, the brake engages and an error message is displayed.

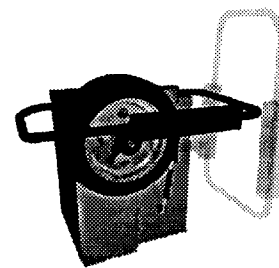

## Offset Scale

Offset, or rim distance, is a measurement of where the wheel is mounted relative to the body of the balancer. The offset scale measures this distance when wheel dimensions are being entered manually. The offset scale is located at the top rear of the head. The offset value is read at the point where the scale arm enters into the housing. This value is entered with the Arrow and Enter buttons on the input panel. The scale is spring-loaded and will return to its resting position when released.

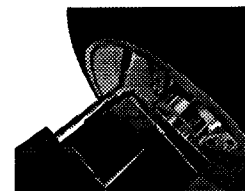

### Calipers

The calipers are used to measure the width of the rim of the wheel being balanced when wheel dimensions are being programmed manually. The width is then programmed with the Arrow and Enter buttons on the input panel. The calipers are stored on a peg at the side of the machine.

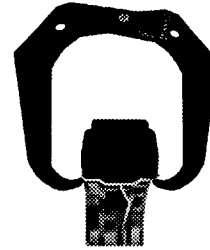

### Storage Pegs

These are situated on the side and rear of the display support and provide locations for storing wheel mounting cones and other accessories.

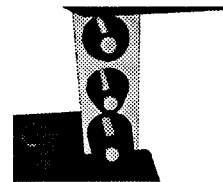

### Weight Tray

This moulded tray contains compartments for weights and storage areas for weight pliers and accessories.

## CONTENTS

Safety Cautions and Warnings .....	ii
Installation and Assembly .....	iii
Installation .....	iii
Assembly Instructions .....	iii
Selection of Ounce/Gram Units .....	iv
Introduction .....	1
Features .....	2
Wheel Mounting Accessories .....	3
Standard Accessories .....	3
Optional Accessories .....	4
Functional Description .....	5
Balancer Display .....	6
Input Panel .....	7
Two-Button Functions .....	8
Offset Scale .....	8
Measuring Frame .....	8
Calipers .....	9
Storage Pegs .....	9
Weight Tray .....	9
Balancing Operation .....	10
Operating Procedure .....	10
Entering Dimensions in Manual Mode .....	13
Balancing Errors .....	14
Weight Modes .....	15
Normal (clip-on) .....	15
Alu 1 .....	15
Alu 2 .....	15
Alu 3 .....	16
Alu 4 .....	16
CTS .....	16
Static .....	16
Special Applications .....	17
Wheel Mounting Methods .....	19
Optimatch: Tire and Rim Matching .....	23
Matching Symbols .....	23
Starting the Matching Procedure .....	24
Starting with Rim only .....	25
Starting with Rim plus Tire .....	27
Calibration .....	31
Weight Calibration Procedure .....	31
Weight Calibration Errors .....	33
Frame Calibration Procedure .....	34
Frame Calibration Errors .....	35
Service and Maintenance .....	36
Operational Check .....	36
Troubleshooting Guide .....	39
Technical Specifications .....	43



## SAFTEY CAUTIONS AND WARNINGS

1. Read the Operators Manual before operating the balancer for the first time. Follow all instructions and warnings marked on the product.
2. The balancer operates from a 110 Vac, 60 Hz power source. Do NOT use any other voltage/frequency electrical outlets. Use only an EARTHED electrical power source. Use only a correctly rated replacement fuse.
3. Arrange the power cord so that it will not be tripped over or pulled, and keep it clear of moving parts. If an extension cord is used, ensure its current rating equals that of the power cord supplied. Immediately replace a damaged power cord.
4. Ensure the balancer rests on all three feet on a clean, level floor with no debris under the base.
5. Do not operate the balancer; a) near fumes or exposed flammable liquids; b) on wet surfaces. Do not expose the balancer to rain.
6. Adopt the correct lifting procedures when lifting any object. Weights in excess of 100lb (45kg) should not be lifted unaided.
7. NEVER remove a cover or access panel on the balancer without first disconnecting the balancer from the electrical power source.
8. Only authorised and trained operators should use the machine.
9. Wear approved eye protection when removing or attaching weights. Keep hair, clothing and all parts of the body clear of balancer moving parts.
10. Remove all stones, old weights, and other debris from the wheel before balancing.
11. Center and tighten the wheel on the shaft before spinning the wheel.
12. Check that all wheel weights are properly applied and secured.
13. The balancer will return to the normal power-up state if the power is interrupted.
14. When the balancer is not in use, disconnect the power cord and use the available pegs and trays for storage of accessories.

## CWB 1858 INSTALLATION & ASSEMBLY

Your CWB 1858 Wheel Balancer and accessories will be delivered in a single carton mounted on a pallet.

### Installation

- A. Unpack the balancer and all accessories.
- B. Check the contents list below and confirm that all parts are present. Check also for the standard wheel mounting accessories and any optional accessories you may have ordered.

<u>Qty</u>	<u>Item</u>
1	Base unit.
1	Display unit.
1	Display support & backpanel.
1	Frame (measuring).
1	Power cord.
1	Set of wheel mounting accessories.
1	Rim width Calipers.
2	Set of weight tray labels.
1	Operators manual.

- C. Place the base unit on a firm solid floor.
- D. Read the *Assembly Instructions* section.

### Assembly Instructions

*Tools required : 0.40" and ½" open end wrench  
Phillips screwdriver.*

1. Remove the *weight tray* by unscrewing the two *Phillips screws*, and then lifting up the *tray* from the *base*, separating it from the *velcro fasteners*.
2. Slide the *display support* into the slots in the machine base, and attach the *M6 bolt and washer* at the side of the *base*. Locate the *display unit* on the *support*, making sure that the cable is on the inside of the *display support*. Slide in the *support backpanel* and attach the four *M6 bolts and washers* into the *backpanel*.

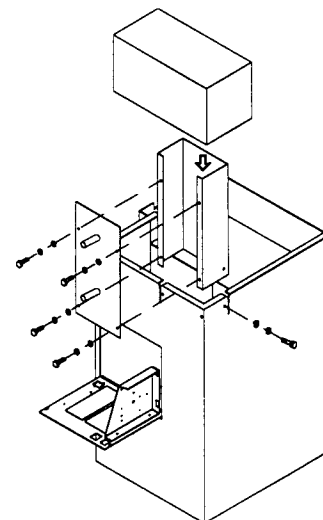
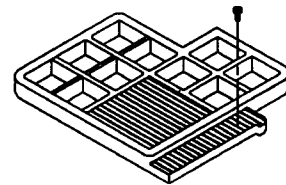

3. Attach the *measuring frame* using the four *nuts and washers* on the *pivot bar*. Connect the *frame cable* and *cable bracket* to the bottom of the *PCB door*.

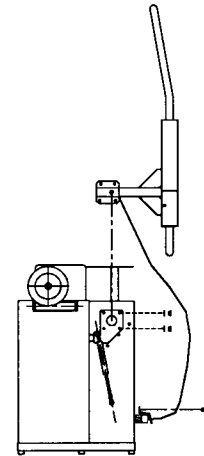

4. Attach the *display cable (2-way)* to the *PCB door* as shown.
5. Re-assemble the *weight tray* by attaching it using the *velcro fasteners* and *screws*.
6. Attach the *PCB door* to the *rear of the base* using the two screws provided.

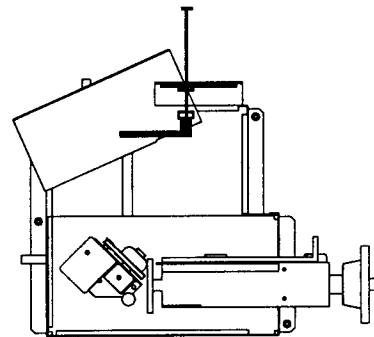

7. Fix the *stub shaft* to the *spindle*, by inserting the bolt and tightening to a torque of 110-130lbs.
8. Verify the correct voltage is shown on the product serial label. Connect balancer to the mains outlet using the power cord provided. Switch on the wheel balancer.

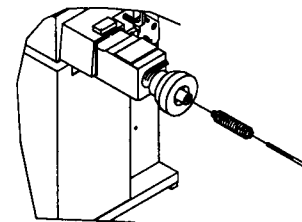

**Your balancer is now ready for use!**

### Selection of Ounce/Gram Units

The balancer is programmed before leaving the factory to display weight imbalance in ounces. To change this setting to gram units, press the Left Arrow button and Match button together for a few seconds, until a decimal point disappears in the display (000). Repeating these steps will change the units back to ounces (0.00).

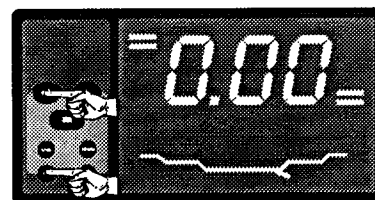

## FEATURES

The SUN CWB 1858 Automatic Wheel Balancer applies the latest technology in wheel balancing for automobile and light truck wheels in an economical and powerful package which includes these features:

- Dynamic (twin-plane) and Static (single- plane) balancing.
- Single-spin cycle (7 seconds).
- Choice of 8 weight location modes :  
Normal, Alu 1, Alu 2, Alu 3, Alu 4, CTS, Static Special.
- Quick and easy entry of wheel dimensions using Automatic or Manual input system (rim diameter, rim width and offset).
- Weight position indicators show exact positions of weights for all balance modes.
- Automatic recalculation of results for changes in wheel dimensions or modes without respinning the wheel.
- Fine mode increases accuracy to within 0.10 ounces (2 grams).
- Ounces or Grams weight units.
- Inches or Millimeters wheel diameter units.
- Optimatch Tire and Rim Matching programme.
- Low-speed balancing and automatic brake for maximum operator safety and equipment protection.
- Automatic self-calibration.
- SPECIAL balancing mode specifying exact weight locations by manually programming an inner and outer rim diameter.
- Low-power motor for minimum power consumption and increased reliability.
- Weight trays and pegs located for convenient storage of weights, cones, springs and other accessories.
- Range of wheel mounting accessories.
- Low service and maintenance costs.
- Bolt-to-floor option.

## WHEEL MOUNTING ACCESSORIES

### Standard Accessories

Quick-Release Hub Nut (P/N 4801-1003)



Cone Spring (P/N WB1131)



Spacer Ring (P/N 8040)



Large Cone (P/N WB1090-01)



Medium Cone (P/N WB1090-02)



Small Cone (P/N WB1090-03)



Extra Small Cone (P/N WB1090-04)



Large Drum (P/N WB1140-01)

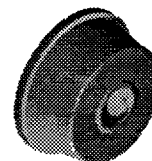

Small Drum (P/N WB1140-02)



**Standard Accessories (cont)**

Large Gasket (P/N WB2533-01)



Small Gasket (P/N WB2533-02)



Stub Shaft (P/N 8322)



Light Truck Cone (P/N WB1133-01)



Extension Adaptor (1") (P/N WB1207-01)



Calipers (P/N WB1158-02)



## Optional Accessories

Universal Wheel Adaptor : (P/N WB1230)

Fits 3,4,5,6,8 and 10-hole patterns. Used on wheels with untrue center holes, and wheels with closed center.



Metric Bolt Plate Adaptor : (P/N WB1499)

Used instead of Universal Wheel Adaptor for wheels with untrue centers or closed centers.



Extra Wide Extension Adaptor : (P/N WB1207-02)

Used for some light truck wheels, reverse offset wheels and any application where wheel must be moved away from machine.



**Additional adaptors and accessories for a variety of wheel mounting applications are available (for example, a motorcycle wheel adaptor kit).**

## FUNCTIONAL DESCRIPTION

The accompanying illustration shows a view from the front of the complete assembled CWB 1858 Wheel Balancer.

1. Input Panel
2. Display Panel
3. Storage Pegs
4. Offset Scale
5. Ultrasonics Measuring Frame
6. Stub Shaft
7. Flange
8. Calliper Peg
9. Weight Tray

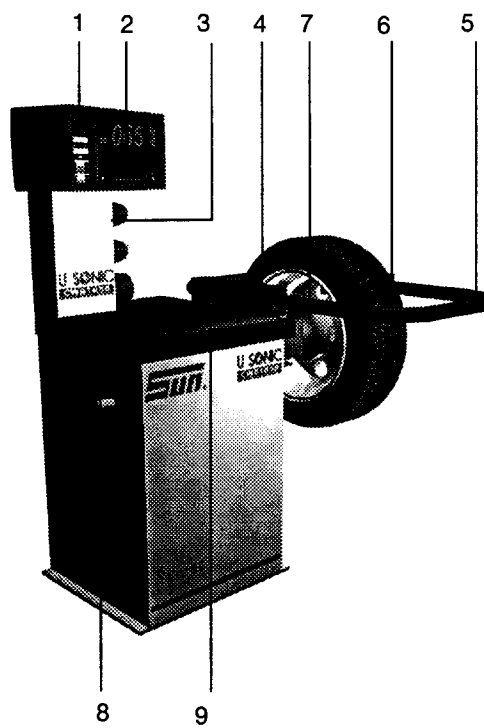



## Balancer Display

The display combines solid-state electronics and graphical design to provide powerful visual presentation and durability.

The display indicates the amount and position of weights, wheel dimensions, operating modes and error conditions.

### 1. Numeric Display

Displays weights in ounces or grams after a spin cycle, when the wheel is rotated to the inner or outer Top-Dead-Center position.

Displays wheel dimensions (diameter, width, offset) in inches or millimeters during wheel data entry.

Displays 'Exx' to report an error.

### 2a. Decimal Point

Used to display weights and wheel dimension values.

### 2b. Ounce indicator

Illuminated constantly when ounces are selected as weight units.

### 3. Weight Position Indicators

Illuminated sequentially as the wheel is rotated. All the indicators on one side are illuminated when the correct position for attaching the weight at Top-Dead-Center (TDC) is reached. This applies to both inner (3a) and outer (3b) weight positions.

### 4. Rim Profile

Graphical rim profile to illustrate the Weight Mode in operation.

### 5. Weight Mode Indicators

Illuminated Clip-on Weight (green, circular) and Stick-on Weight (yellow, rectangular) indicators to correspond to the Weight Mode selected.

### 6. Mode Indicators

These indicate specific operating states:

- 6a. Standard/Fine accuracy
- 6b. Automatic/Manual wheel dimensions
- 6c. Matching indicator.

### 7. MM Indicator

Illuminated constantly when millimeters are selected as rim diameter units.

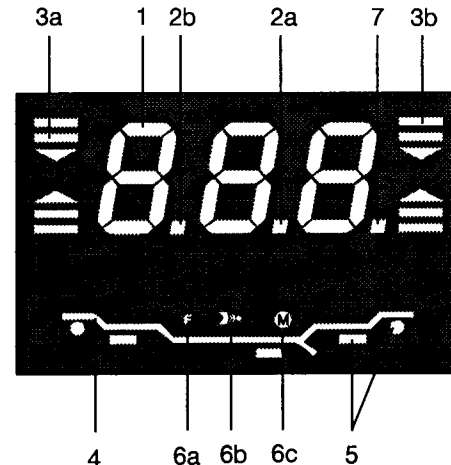

## Input Panel

The input panel contains controls, positioned for convenience, with graphical symbols clearly defining each function.

The input panel is used to select specific operating states and to enter data for the wheel to be balanced and the weights to be used.

### 1. Fine

Used in any mode to balance a wheel to within 0.10 ounces/2 grams (rather than the normal 0.25 ounces/ 5 grams).

### 2. Mode

Selects the Weight Mode. The mode selected is indicated by the weight mode indicators on the rim profile in the display panel. The balancer automatically recalculates the weights and positions for balancing the wheel when a new weight mode is selected without the need to re-spin the wheel.

### 3. Match

Used to start the Optimatch (Tire and Rim Matching) programme. Press Mode to exit the Optimatch programme.

### 4. Auto

This selects Automatic Dimensions mode. Press again to return to Manual Dimensions.

### 5. Left Arrow

### 6. Right Arrow

### 7. Enter

These are used to program dimensions manually and to select Two-Button functions.

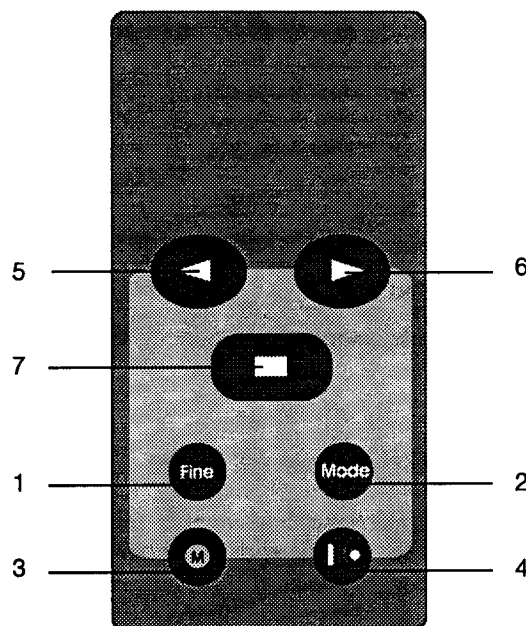

## TWO-BUTTON FUNCTIONS

Press and hold both buttons together for 1 second:

### *Left Arrow + Right Arrow (5 + 6)*

Changes wheel diameter units from inches to millimeters or vice-versa.

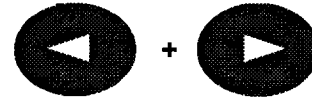

### *Left Arrow + Match (5 + 3)*

Changes weight units from ounces to grams or vice-versa.



### *Left Arrow + Auto (5 + 4)*

Start Automatic Dimensions (Frame) Calibration programme.



### *Left Arrow + Fine (5 + 1)*

Start Automatic Weight Calibration programme.



### *Right Arrow + Match (6 + 3)*

Used to enable or disable Matching Recommended indication.



## Measuring Frame

In Automatic mode, the rim diameter, rim width and rim offset are measured and programmed automatically when the measuring frame is lowered. Lowering the measuring frame also activates the motor and spins the wheel up to measuring speed. When the wheel reaches measuring speed, the motor disengages. The frame is raised after the measuring cycle is completed, when the brake has been automatically applied. If the frame is raised before the measuring cycle is completed, the brake engages and an error message is displayed.

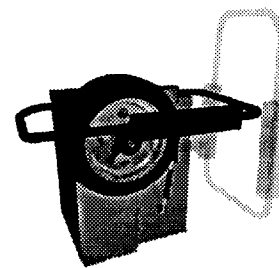

## Offset Scale

Offset, or rim distance, is a measurement of where the wheel is mounted relative to the body of the balancer. The offset scale measures this distance when wheel dimensions are being entered manually. The offset scale is located at the top rear of the head. The offset value is read at the point where the scale arm enters into the housing. This value is entered with the Arrow and Enter buttons on the input panel. The scale is spring-loaded and will return to its resting position when released.

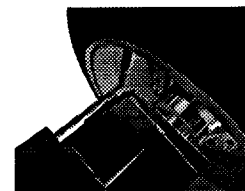

### Calipers

The calipers are used to measure the width of the rim of the wheel being balanced when wheel dimensions are being programmed manually. The width is then programmed with the Arrow and Enter buttons on the input panel. The calipers are stored on a peg at the side of the machine.

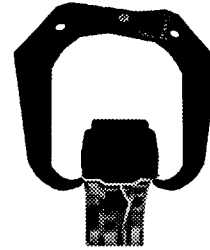

### Storage Pegs

These are situated on the side and rear of the display support and provide locations for storing wheel mounting cones and other accessories.

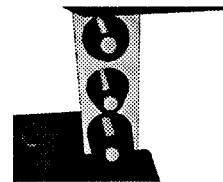

### Weight Tray

This moulded tray contains compartments for weights and storage areas for weight pliers and accessories.

## BALANCING OPERATION

CWB 1858 operation to balance a wheel is based upon a short sequence of actions which are intuitive, efficient and simple.

### Operating Procedure

The following summary covers the main steps for fast, accurate wheel balancing with the CWB 1858. Later sections of this manual contain more detailed information on weight location modes and wheel mounting methods for your balancer.

#### 1. Mount the wheel.

Select the accessories appropriate to the method of wheel mounting to be used (refer to the *Wheel Mounting Methods* section).

Careful wheel mounting is essential, as the wheel is balanced relative to how well it is mounted on the balancer. If the wheel is not well centered and sitting squarely against the balancer flange plate, accurate balance results will not be achieved.

Most stud-centered wheels have concentric center holes, which allow fast and easy cone mounting. Adaptors should be used only in problem situations and on some aftermarket specialty wheels.

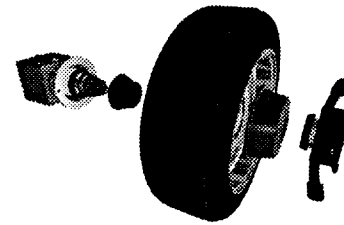

#### 2. Select Weight Mode (if necessary).

Press Mode on the input panel to set the Weight Mode Indicators on the rim profile for the types and locations of weights to be used to balance the wheel.

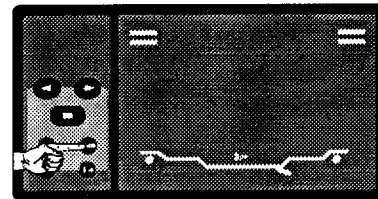

#### 3. Select Fine Mode (if necessary).

Press Fine if the wheel is to be balanced to within 0.10 ounces/2 grams. The Fine indicator will be lit on the display panel. Press Fine again to reset the standard 0.25 ounces/5 grams. Fine Mode may also be set or cleared after the measuring cycle is over and the results displayed; new results will be automatically recalculated.

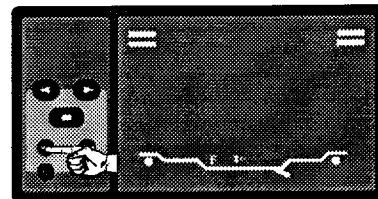

## BALANCING OPERATION

CWB 1858 operation to balance a wheel is based upon a short sequence of actions which are intuitive, efficient and simple.

### Operating Procedure

The following summary covers the main steps for fast, accurate wheel balancing with the CWB 1858. Later sections of this manual contain more detailed information on weight location modes and wheel mounting methods for your balancer.

#### 1. Mount the wheel.

Select the accessories appropriate to the method of wheel mounting to be used (refer to the *Wheel Mounting Methods* section).

Careful wheel mounting is essential, as the wheel is balanced relative to how well it is mounted on the balancer. If the wheel is not well centered and sitting squarely against the balancer flange plate, accurate balance results will not be achieved.

Most stud-centered wheels have concentric center holes, which allow fast and easy cone mounting. Adaptors should be used only in problem situations and on some aftermarket specialty wheels.

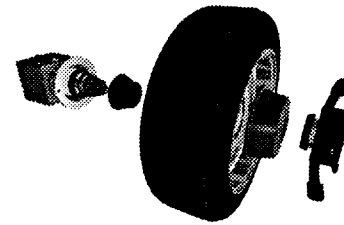

#### 2. Select Weight Mode (if necessary).

Press Mode on the input panel to set the Weight Mode Indicators on the rim profile for the types and locations of weights to be used to balance the wheel.

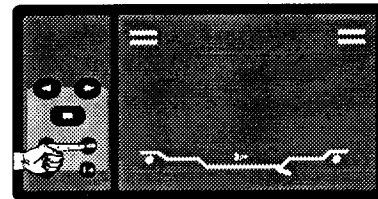

#### 3. Select Fine Mode (if necessary).

Press Fine if the wheel is to be balanced to within 0.10 ounces/2 grams. The Fine indicator will be lit on the display panel. Press Fine again to reset the standard 0.25 ounces/5 grams. Fine Mode may also be set or cleared after the measuring cycle is over and the results displayed; new results will be automatically recalculated.

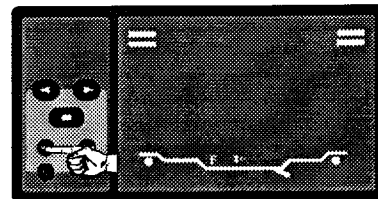

In Automatic mode (Auto indicator lit) skip to step 7 (there is no need to program the wheel dimensions.)

To set Automatic mode if the Auto indicator is not lit, press Auto on the input panel.

OR

To balance in Manual Mode, press Enter. The green Auto indicator will not be lit. (Proceed through Steps 4 to 6.)

4. Program the Rim Diameter.

The display shows 2 red weight position indicators illuminated on the inner side and a value on the numeric display. Read the wheel diameter, in inches or millimeters, from the tire sidewall.

Press the Left Arrow button to lower the value and press the Right Arrow button to raise the value, and the numeric display will change. When the correct value appears, press Enter to input the diameter.

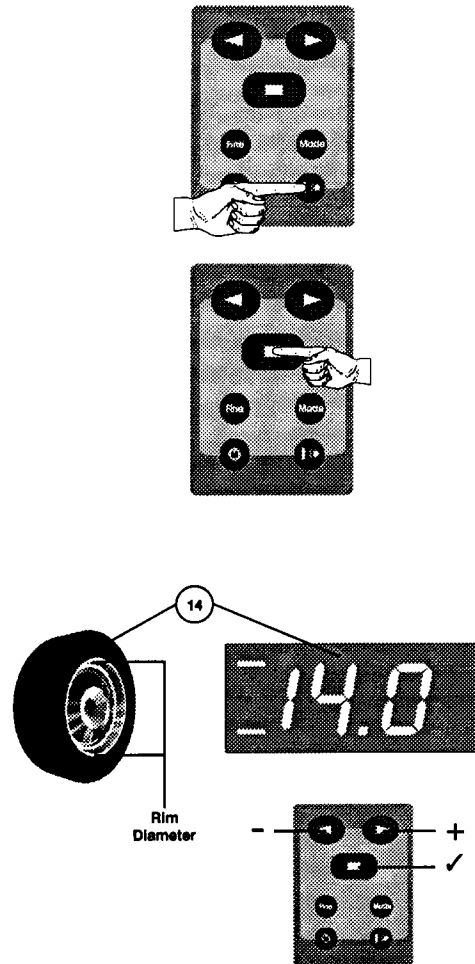

5. Program the Rim Width.

The display shows 1 red weight position indicator illuminated on both the inner side and outer side, and a value on the numeric display. Measure the width of the rim using the calipers - read the width, in inches, from the scale on the calipers.

Press the Left Arrow button to lower the value and press the Right Arrow button to raise the value, and the numeric display will change. When the correct value appears, press Enter to input the width.

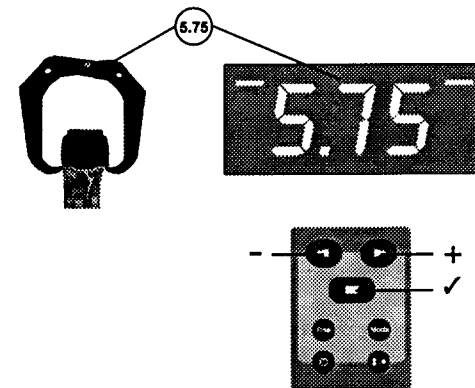

### 6. Program the Rim Offset.

The display shows 1 red weight position indicator illuminated on the inner side and a value on the numeric display. Pull the offset scale out and position the tip against the rim flange surface of the wheel. (regardless of where the inner weight will be placed). Read the offset value off the scale at the point where it enters into the housing.

Press the Left Arrow button to lower the value and press the Right Arrow button to raise the value, and the numeric display will change. When the correct value appears, press Enter to input the offset.

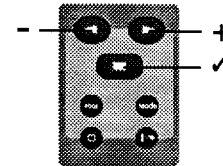
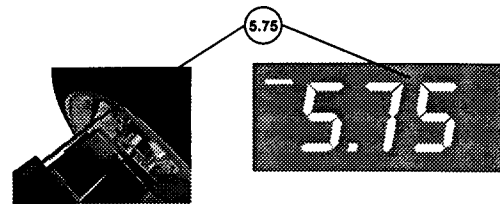

### 7. Spin the wheel.

**MOTOR-SPIN:** Lower the frame to start the motor which will automatically spin the wheel up to measuring speed. In Automatic Mode, the dimensions of the wheel are scanned as the frame is lowered.

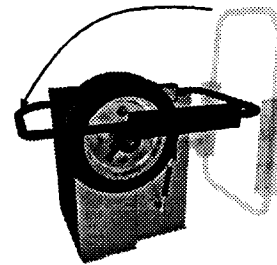

OR

**HAND-SPIN:** This method is only valid in Manual mode. Using the hub nut handle, turn the wheel clockwise until the balancer beeps, then release the handle. The wheel will continue to rotate for the duration of the measuring cycle. If the wheel is spun too fast, the beeps will sound continuously until the wheel slows to the proper measuring speed and the balancer can perform its measuring cycle as normal.

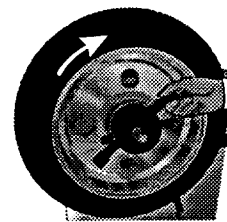

**Do not interfere with the balancer or with the wheel during the measuring cycle as wrong results may occur.**

When the measuring cycle is complete, the brake is automatically applied to slow the wheel. Raise the frame if the wheel was not hand-spun.



#### 8. Attach the weights.

Starting with either side of the wheel, rotate the wheel until all 6 weight position indicators for that side of the wheel are lit. The correct balance weight will now be displayed.

Apply the displayed weight securely at the Top-Dead-Center (12 o'clock) position on the wheel. Repeat these steps for the other side of the wheel.

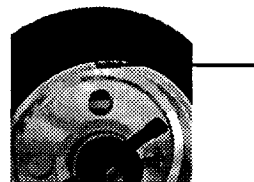

#### 9. Do a check spin.

Spin the wheel again (Step 7). The display should indicate a balanced wheel by showing '000' constantly (i.e. regardless of wheel position).



**At this point, Fine Mode may be set or cleared, the Weight Mode may be changed, or the wheel dimensions (diameter, width, offset) may be altered. The balancer will automatically recalculate the correct results for the new settings without the need to re-spin the wheel.**

### Entering Dimensions in Manual Mode

The following points should be noted:

- If the wheel diameter units are set to millimeters, the diameter value displays as 'mmm'. Pressing the Left Arrow and Right Arrow changes the diameter to the next standard millimetric diameter value.
- If the CTS weight location mode is selected, the rim diameter is automatically shown in millimeters, from a table of CTS rim diameters.
- In Alu 3 and Alu 4 weight location modes, the width is fixed at 4.00".
- In Special weight location mode, the inner and outer diameters will change in increments of 0.25" rather than 1.0".

## Balancing Errors

The CWB 1858 wheel balancer is equipped with a Diagnostic Self-Test program which automatically tests the internal electronics and cabling of the balancer every time the power is turned on. It also detects errors during operation if the procedure is carried out incorrectly. An error code is displayed for 3 seconds and the balancer beeps twice when such errors occur.

Each error code is specific to a type of error ensuring that the cause of a fault or incorrect action may be quickly established. If a failure is reported, record the error code and switch off the machine. Turn on the machine again after 5 seconds and check if the error code remains. If the fault persists, report the error code to your service representative.

If the wheel is intentionally or accidentally slowed or stopped during the measuring cycle, the display will report an error. Spinning the wheel up to balancing speed again will remove this error and allow the balancer to function normally.

If repeatable results cannot be achieved, there is a possibility of foreign material moving around inside the tire and causing a different imbalance every time. This material must first be removed before the wheel can be balanced.

If readings appear to be inconsistent or additional weights are continually called for, verify that the wheel is not slipping on the flange when the brake is applied.

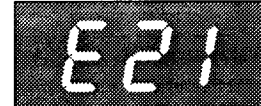

## WEIGHT MODES

The CWB 1858 features one Normal weight mode for clip-on weights only, four Alu weight modes for combinations of clip-on and stick-on weights and a CTS weight mode for the Continental Tire System wheels. In addition, static weight mode is for static balancing where a single weight is to be applied.

Pressing Mode on the input panel sequences through the weight modes. The Weight Mode indicators on the rim profile indicate the selected weight types and placements.

When attaching the weights, observe the placement dimensions shown in the diagrams for each mode. The balancer is programmed for these dimensions; other placement locations will require different weights.

For simple and accurate balancing, the Normal weight mode may be used for all balancing measurements. After the balancing cycle, use Mode on the input panel to set the required weight mode. The balancer will automatically recalculate the weights required for the new weight mode.

On the rim profile, clip-on weights are indicated by green, circular lights; stick-on weights are indicated by yellow, rectangular lights.

*Normal*: Standard clip-on weights are applied, one to each of the inner and outer rim flanges.

*Alu 1*: A standard clip-on weight is applied on the inner rim flange. A stick-on weight is used on the outer bead seat of the rim.

*Alu 2*: Stick-on weights are applied, one on the inner and the second on the outer bead seat areas of the rim.



**Alu 3** : A standard clip-on weight is used on the inner rim flange and a stick-on weight is applied towards the center area of the rim. This is a 'hidden-weight' technique - the weights should not be visible when the wheel is replaced on a car.

**Alu 4** : This is another 'hidden-weight' method. One stick-on weight is applied on the inner bead seat area and a second stick-on weight is applied towards the center area of the rim.

When using the Alu 3 or Alu 4 Modes, the inner and outer weights **MUST** be placed the correct distance apart longitudinally (dimension "D"). The balancer is programmed for this distance when using these weight modes. If it is necessary to use weight placements not catered for in the section, refer to the *Special Applications* section.

**CTS** : This weight mode is only available in Manual mode. In this weight mode, the same stick-on weight indicators as set in Alu 2 are lit. The weights should be placed in the grooves on the inner and outer wheel-well areas as shown opposite. Use the rim diameter as shown on the tire sidewall (millimetric) to program the balancer.

**Static Balancing** : Only one stick-on weight indicator is lit; however, either a single clip-on or stick-on weight may be used. The weight can be positioned on the inner or outer rim flange, or towards the center of the rim. If the imbalance is large, the amount of weight required can be divided equally between the inner and outer rim flanges.

For static balancing, the rim width and offset dimensions do not need to be entered into the balancer. Only the wheel diameter must be programmed. After the measuring cycle, the inner (left) weight position indicators will be used to indicate the TDC position for the static balancing weight (the outer indicators will not display).

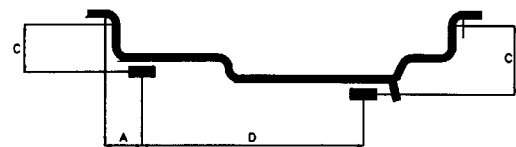
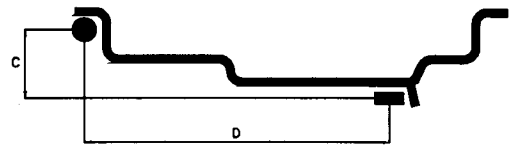

- A = 0.5"/1.25cm
- B = 0.75"/2cm
- C = 1.5"/4cm
- D = 4.0"/10cm

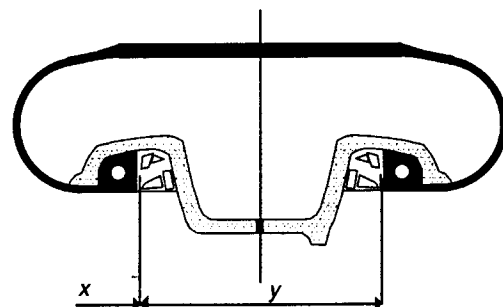

## Special Applications

Occasionally it may be necessary to use weight locations which are different from those used in the standard Alu programmes. This will usually only occur for hidden weight methods, where the distance between the weights of 10 cm (4") is not suitable. If situations are encountered where special weight locations are required proceed as follows:-

1. Select Special weight mode.

Ensure the balancer is in Special mode. Press Mode on the input panel repeatedly until the two clip-on and two stick-on weight mode indicators flash alternately.

2. Program the diameter.

Use the Arrow and Enter buttons on the input panel to set the diameters at which the hidden weights will be applied. Firstly, program the Inner diameter and press Enter to select. Repeat for the Outer diameter. These diameters may be specified to the nearest 0.25".

3. Program the width.

Measure the distance between the two locations A and B where the weights will be applied. If weight B is a hidden weight use a tape measure or rule. If weight B is on the outer rim, the calipers can be used. Use the Arrow and Enter buttons on the input panel to set the width.

4. Program the offset.

Pull the offset scale out and position the tip at the point where the inner weight is to be located. Read the offset value from the scale, use the Arrow and Enter buttons on the input panel to set the offset.

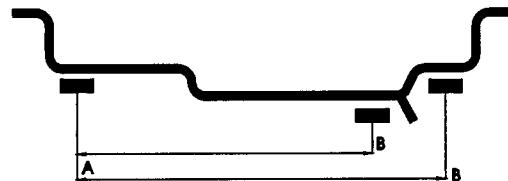
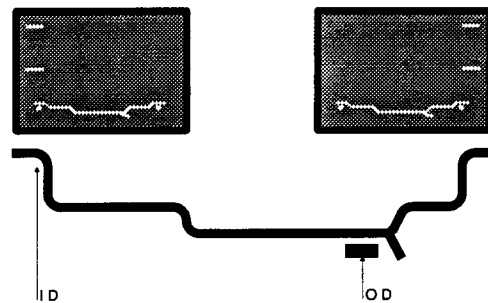

5. Spin the wheel.

Complete normal balance routine.

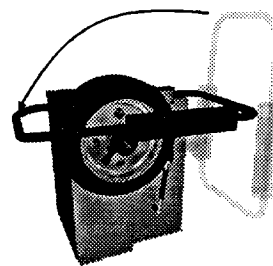

6. Attach the weights.

Rotate the wheel until the TDC position on either side of the wheel is reached. Attach the displayed weight amount at the TDC (12 o'clock) position. Repeat this procedure for the other side of the wheel.

**If the weights are not attached at the correct locations (as measured), accurate balance results will not be achieved.**

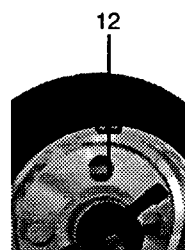

7. Do a check spin.

Repeat the normal balancing routine. The display should indicate a balanced wheel by showing '0.00' constantly (i.e. regardless of wheel position).



## WHEEL MOUNTING METHODS

### Back Cone Mounting

Back cone mounting is the most common way to mount automobile wheels. Choose the cone that fits best when placed through the wheel center hole from the rear. Slide the cone spring and cone on the shaft. Place the wheel on the cone and be sure that the cone centers the wheel when you tighten the handle.

The pressure drum should contact the wheel on a flat surface. Do not center the wheel with the pressure drum. Tighten the wheel firmly against the mounting flange. Hold the handle in place and rotate the wheel when tightening. Be sure that the wheel is firmly against the mounting flange and the handle threads engage at least three turns on the shaft.

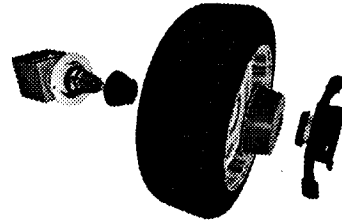

### Front Cone Mounting

Front cone mounting is required when using light truck wheels and is also an acceptable alternative for many automobile wheels. The wheel center hole must be true on the outside of the wheel to use the front cone mounting method.

Choose the cone that fits best when placed through the wheel center hole from the front. Slide the wheel on the balancer shaft without a back cone or spring on the shaft. Place a cone on the shaft, through the front of the wheel. Be sure the cone centers the wheel and that the wheel is squarely against the mounting flange when you tighten the handle.

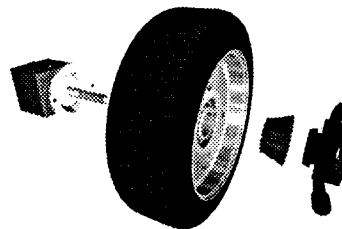

### Back Cone Mounting without Pressure Drum

Ensure the handle does not contact the cone, or the wheel will not be centered and mounted securely. Attach the spacer ring to the hub nut if this situation occurs.

**On some extended-center wheels with small hub diameters, the pressure drum cannot contact the front face of the wheel properly. Such wheels can be mounted using the standard back cone method without a pressure drum. Check that the handle contacts the wheel center evenly and that the wheel is centered on the cone.**

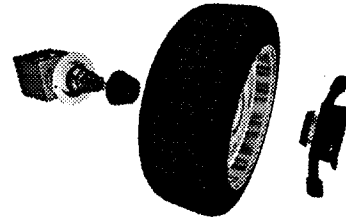

### Double Cone Mounting

The cones must not touch each other. If the cones touch, the wheel will not be centered and mounted securely.

**Double cone mounting can be used for some specialty wheels, such as those on a Porsche 928. The back cone centers on the formed part of the wheel, and the front cone centers on the hole.**

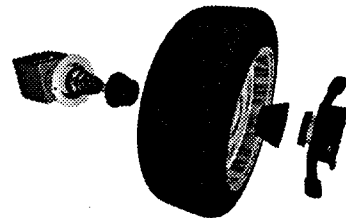

### Front Cone Mounting with an Extension Adaptor

The extension adaptor may be required for some light truck wheels and reverse-offset wheels that must be moved away from the balancer mounting flange. The extension adaptor is often used with the 5-1/2-inch diameter light truck cone.

Install the extension adaptor on the mounting flange with the knurled thumbnuts provided. Then mount the wheel, using the normal front cone method.

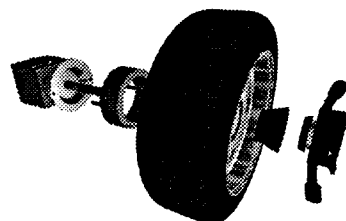



### Universal Wheel Adaptor

This adaptor is used on wheels with untrue center holes and wheels with closed centers or for any application where automotive mounting cones can not be used. Instructions for use are supplied with the adaptor.



### Metric Bolt Plate Adaptor

The metric bolt plate adaptor is an alternative to the universal wheel adaptor. The adaptor is used on wheels with untrue center holes, wheels with closed center holes as found on many French vehicles, or where the wheel is centered on the wheel mounting studs rather than by conical wheel mounting nuts. Instructions for use are supplied with the adaptor.



### Wheel Mounting Errors

Regardless of the mounting method used, the wheel must be centered before balancing. A wheel should be mounted on the appropriate cone or adaptor and tightened carefully to ensure proper centering and mating against the balancer flange.

The wheel must be clean and free of large burrs or nicks, especially where it mates with the cone or adaptor and the balancer flange. Any dirt between the flange and the mating surface of the wheel will cause misalignment on the shaft. A misalignment of the thickness of a matchbook cover will cause an unbalance of 0.50 ounces (15 grams) or more on automobile wheels and 1 ounce (30 grams) on light truck wheels.

The wheel must also be tightened securely to prevent it from slipping in relation to the flange. If the wheel slips on the balancer, accurate weight measurement and location are impossible.

## Wheel Rotational Errors

When a wheel is mounted on the balancer, whether using a cone or an adaptor, it is fixed in a particular position in relation to the balancer shaft. If the wheel is rotated 180 degrees from the initial position and re-tightened, a different balance reading may result. Such differences are called rotational errors.

When checking balance with the wheel in one position and then rotating it 180 degrees and re-spinning it, the difference between the two readings could be as much as 0.50 ounces (15 grams) for cone-mounted automobile wheels, and 2 ounces (60 grams) for light truck wheels.

The actual balance error is one-half of the displayed amount because the reading is the sum of the error and the weight required to counterbalance the error.

To do a rotational test, first fine-balance the wheel. Then loosen the wheel on the shaft, rotate it 180 degrees, and re-tighten the handle. Spin the wheel in the normal mode to check for rotational errors.

## OPTIMATCH TIRE AND RIM MATCHING

Wheel balancing may sometimes be improved by matching the tire to the rim of the wheel. The Optimatch programme matches the rim imbalance (heavy spot) and rim runout against the tire imbalance and runout. Wheel vibrations due to out-of-round conditions and hard or soft spots in the rim or tire, can be reduced by matching.

The CWB 1858 provides an option which informs the user after a spin cycle that balancing may be further improved by using the Optimatch programme. If this option is selected, the green Matching Indicator flashes 5 times. This option is selected (or deselected) by pressing the Right Arrow (>) and Match on the input panel for 1 second.

### Matching Symbols

The following symbols are used in the display during the Optimatch programme, to indicate modes and further instructions for use.

a) Rim-Only



b) Rim+Tire

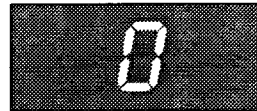

c) Move the valve to the 12 o'clock position



d) Any time the "M" flashes, press the Match button on the input panel.

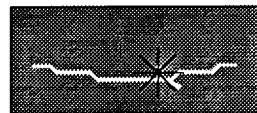

e) Spin the wheel



## Starting the Matching Procedure

To start the Optimatch programme, press Match on the input panel. The balancer will beep and the Rim-Only indicator will light.

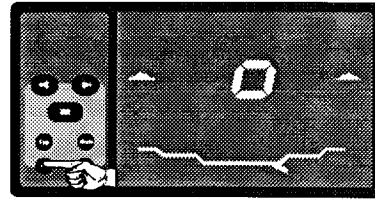

To exit the Optimatch programme at any time, press Mode on the input panel. The balancer will return to normal dynamic balancing.

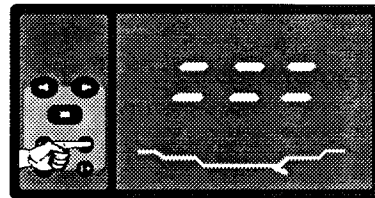

If you are starting with the rim only mounted on the balancer, proceed to the Starting with Rim Only section.

If you want to start with the tire on the rim, press either the Left Arrow (<) or the Right Arrow (>) on the input panel. The Rim+Tire indicator will be displayed instead of the Rim-Only indicator. Proceed to the Starting with Rim+Tire section.

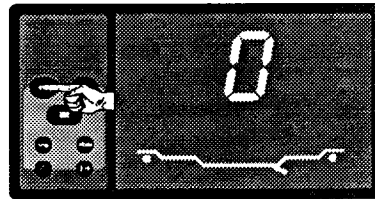

The CWB 1858 automatically exits from the Optimatch programme after a spin cycle, if it calculates that matching would not further improve balancing. This occurs when:

- a) The rim has only a small imbalance.
- b) The rim+tire combination has only a small imbalance (ie. the rim and tire heavy spots are already in the best position for matching).

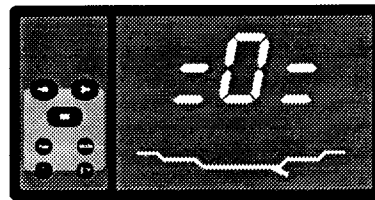
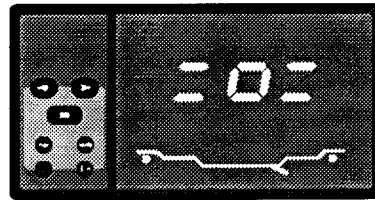

## Starting with Rim Only

1. Ensure that the Rim-Only indicator is displayed. Mount the rim on the balancer and spin.

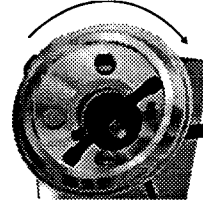
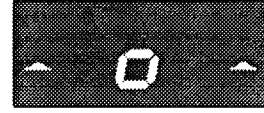

2. After the rim is spun, the green Matching indicator flashes and the balancer beeps. Move the valve to the TDC (12 o'clock) position.

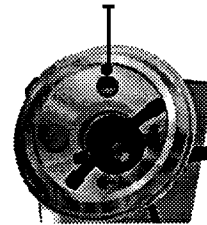
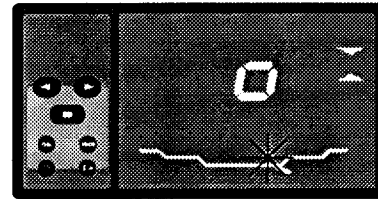

3. With the valve at TDC, press Match on the input panel. The Matching indicator is turned off and the Rim+Tire indicator is displayed.

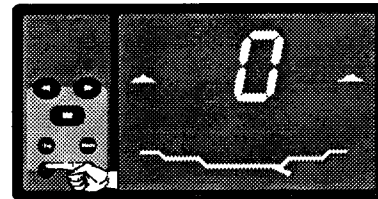

4. Dismount the rim and fit the tire to the rim.

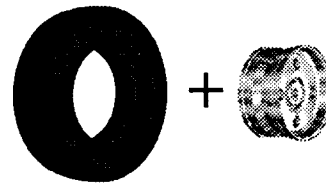

5. Mount the rim with tire on the balancer and spin.

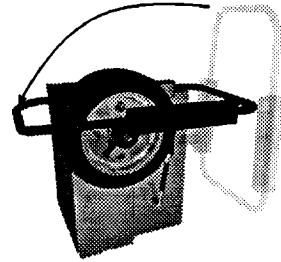

6. When the wheel stops, the green Matching indicator flashes and the balancer beeps. Move the valve to the TDC (12 o'clock) position.

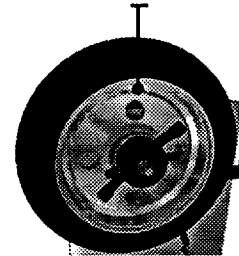
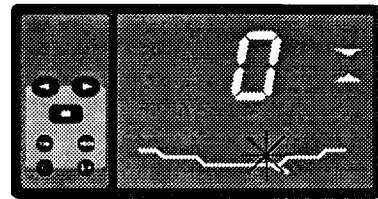

7. With the valve at TDC, press Match on the input panel. The Matching indicator goes out.

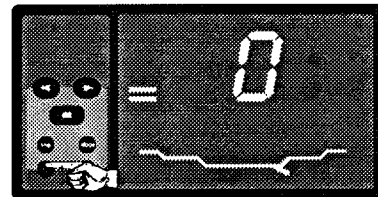

8. Rotate the rim with tire until the numeric display reads "-0-". The Matching indicator flashes and the balancer beeps.

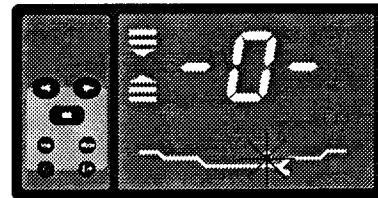

9. Mark an 'X' on the tire at the TDC (12 o'clock) position. Press Match on the input panel.

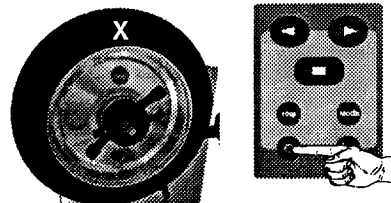

10. The Matching indicator goes off and the display shows " = = =" for a few seconds.

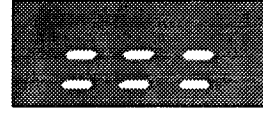

11. Rotate the tire on the rim until the 'X' on the tire is aligned with the valve on the rim.

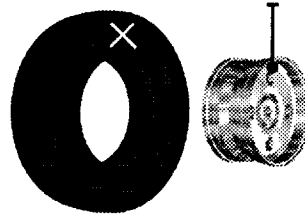

The procedure is now complete and the balancer has exited the Optimatch programme. Normal balancing operation may be resumed.

### Starting with Rim plus Tire

1. Ensure the Rim+Tire indicator is displayed. The Matching indicator flashes and balancer beeps.

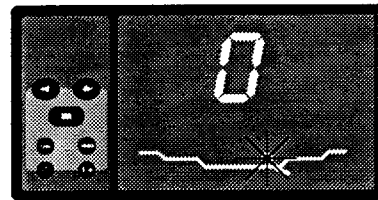

2. Mark a line on the tire at the valve. Press Match on the input panel and the Matching indicator goes out.

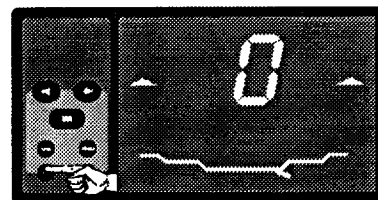
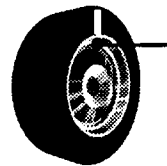

3. Mount the rim with tire on the balancer and spin.

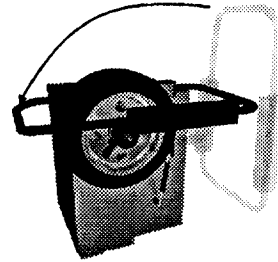

4. The Matching indicator flashes and the balancer beeps. When the wheel stops move the valve to the TDC (12 o'clock) position.

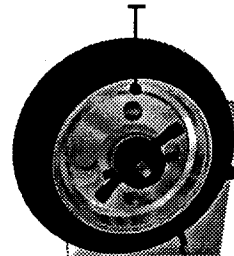
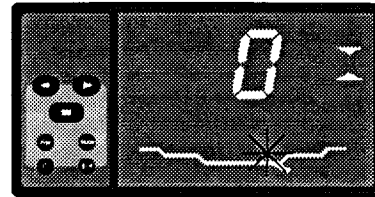

5. Press Match on the input panel. The Matching indicator goes out. The Rim+Tire indicator is turned off and the Rim-Only indicator is displayed.

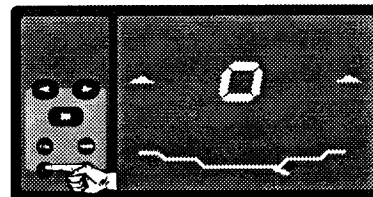

6. Dismount the rim with tire and remove the tire from the rim.

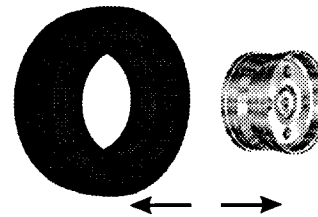

7. Mount the rim only on the balancer and spin.

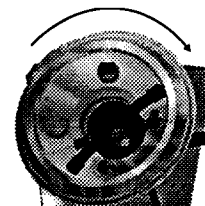



## CWB 1858 INSTALLATION & ASSEMBLY

Your CWB 1858 Wheel Balancer and accessories will be delivered in a single carton mounted on a pallet.

### Installation

- A. Unpack the balancer and all accessories.
- B. Check the contents list below and confirm that all parts are present. Check also for the standard wheel mounting accessories and any optional accessories you may have ordered.

<u>Qty</u>	<u>Item</u>
1	Base unit.
1	Display unit.
1	Display support & backpanel.
1	Frame (measuring).
1	Power cord.
1	Set of wheel mounting accessories.
1	Rim width Calipers.
2	Set of weight tray labels.
1	Operators manual.

- C. Place the base unit on a firm solid floor.
- D. Read the *Assembly Instructions* section.

### Assembly Instructions

*Tools required : 0.40" and ½" open end wrench  
Phillips screwdriver.*

1. Remove the *weight tray* by unscrewing the two *Phillips screws*, and then lifting up the *tray* from the *base*, separating it from the *velcro fasteners*.
2. Slide the *display support* into the slots in the machine base, and attach the *M6 bolt and washer* at the side of the *base*. Locate the *display unit* on the *support*, making sure that the cable is on the inside of the *display support*. Slide in the *support backpanel* and attach the four *M6 bolts and washers* into the *backpanel*.

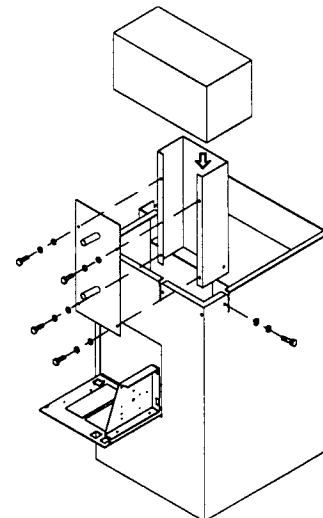
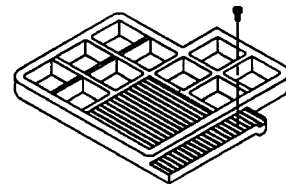

3. Attach the *measuring frame* using the four *nuts and washers* on the *pivot bar*. Connect the *frame cable* and *cable bracket* to the bottom of the *PCB door*.

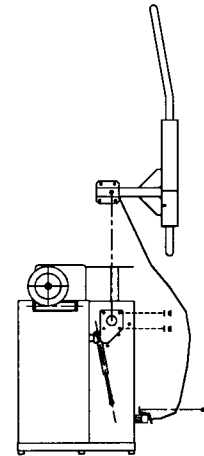

4. Attach the *display cable (2-way)* to the *PCB door* as shown.
5. Re-assemble the *weight tray* by attaching it using the *velcro fasteners and screws*.
6. Attach the *PCB door* to the *rear of the base* using the two screws provided.

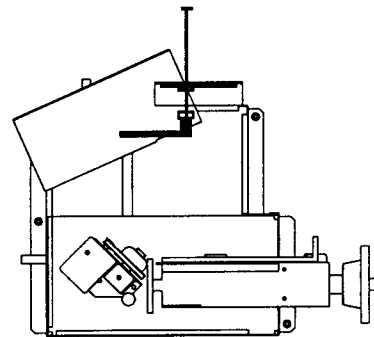

7. Fix the stub shaft to the spindle, by inserting the bolt and tightening to a torque of 110-130lbs.
8. Verify the correct voltage is shown on the product serial label. Connect balancer to the mains outlet using the power cord provided. Switch on the wheel balancer.

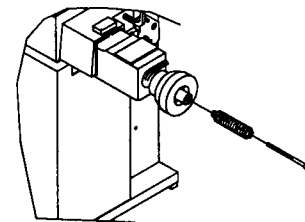

**Your balancer is now ready for use!**

### Selection of Ounce/Gram Units

The balancer is programmed before leaving the factory to display weight imbalance in ounces. To change this setting to gram units, press the Left Arrow button and Match button together for a few seconds, until a decimal point disappears in the display (000). Repeating these steps will change the units back to ounces (0.00).

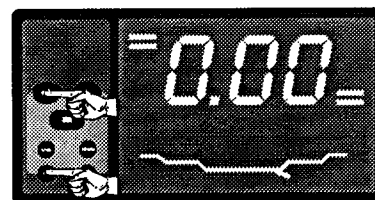

## FEATURES

The SUN CWB 1858 Automatic Wheel Balancer applies the latest technology in wheel balancing for automobile and light truck wheels in an economical and powerful package which includes these features:

- Dynamic (twin-plane) and Static (single- plane) balancing.
- Single-spin cycle (7 seconds).
- Choice of 8 weight location modes :  
Normal, Alu 1, Alu 2, Alu 3, Alu 4, CTS, Static Special.
- Quick and easy entry of wheel dimensions using Automatic or Manual input system (rim diameter, rim width and offset).
- Weight position indicators show exact positions of weights for all balance modes.
- Automatic recalculation of results for changes in wheel dimensions or modes without respinning the wheel.
- Fine mode increases accuracy to within 0.10 ounces (2 grams).
- Ounces or Grams weight units.
- Inches or Millimeters wheel diameter units.
- Optimatch Tire and Rim Matching programme.
- Low-speed balancing and automatic brake for maximum operator safety and equipment protection.
- Automatic self-calibration.
- SPECIAL balancing mode specifying exact weight locations by manually programming an inner and outer rim diameter.
- Low-power motor for minimum power consumption and increased reliability.
- Weight trays and pegs located for convenient storage of weights, cones, springs and other accessories.
- Range of wheel mounting accessories.
- Low service and maintenance costs.
- Bolt-to-floor option.

## WHEEL MOUNTING ACCESSORIES

### Standard Accessories

Quick-Release Hub Nut (P/N 4801-1003)



Cone Spring (P/N WB1131)



Spacer Ring (P/N 8040)



Large Cone (P/N WB1090-01)



Medium Cone (P/N WB1090-02)



Small Cone (P/N WB1090-03)



Extra Small Cone (P/N WB1090-04)



Large Drum (P/N WB1140-01)

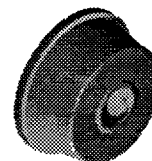

Small Drum (P/N WB1140-02)



**Standard Accessories (cont)**

Large Gasket (P/N WB2533-01)



Small Gasket (P/N WB2533-02)



Stub Shaft (P/N 8322)



Light Truck Cone (P/N WB1133-01)



Extension Adaptor (1") (P/N WB1207-01)



Calipers (P/N WB1158-02)



## Optional Accessories

Universal Wheel Adaptor : (P/N WB1230)

Fits 3,4,5,6,8 and 10-hole patterns. Used on wheels with untrue center holes, and wheels with closed center.



Metric Bolt Plate Adaptor : (P/N WB1499)

Used instead of Universal Wheel Adaptor for wheels with untrue centers or closed centers.



Extra Wide Extension Adaptor : (P/N WB1207-02)

Used for some light truck wheels, reverse offset wheels and any application where wheel must be moved away from machine.



**Additional adaptors and accessories for a variety of wheel mounting applications are available (for example, a motorcycle wheel adaptor kit).**

## FUNCTIONAL DESCRIPTION

The accompanying illustration shows a view from the front of the complete assembled CWB 1858 Wheel Balancer.

1. Input Panel
2. Display Panel
3. Storage Pegs
4. Offset Scale
5. Ultrasonics Measuring Frame
6. Stub Shaft
7. Flange
8. Calliper Peg
9. Weight Tray

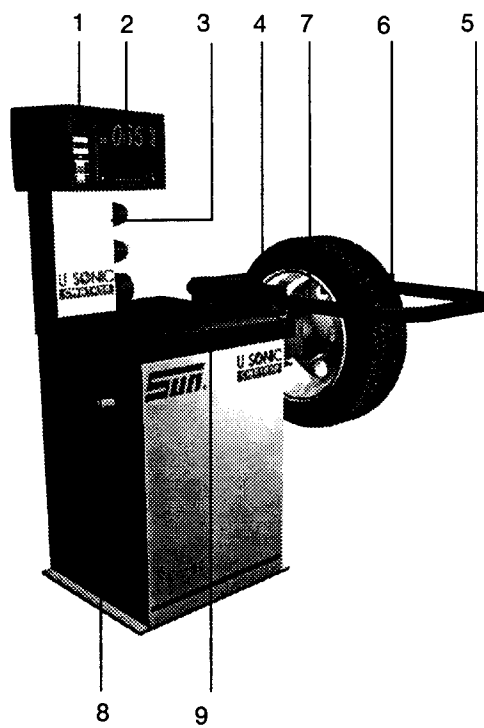

## Balancer Display

The display combines solid-state electronics and graphical design to provide powerful visual presentation and durability.

The display indicates the amount and position of weights, wheel dimensions, operating modes and error conditions.

### 1. Numeric Display

Displays weights in ounces or grams after a spin cycle, when the wheel is rotated to the inner or outer Top-Dead-Center position.

Displays wheel dimensions (diameter, width, offset) in inches or millimeters during wheel data entry.

Displays 'Exx' to report an error.

### 2a. Decimal Point

Used to display weights and wheel dimension values.

### 2b. Ounce indicator

Illuminated constantly when ounces are selected as weight units.

### 3. Weight Position Indicators

Illuminated sequentially as the wheel is rotated. All the indicators on one side are illuminated when the correct position for attaching the weight at Top-Dead-Center (TDC) is reached. This applies to both inner (3a) and outer (3b) weight positions.

### 4. Rim Profile

Graphical rim profile to illustrate the Weight Mode in operation.

### 5. Weight Mode Indicators

Illuminated Clip-on Weight (green, circular) and Stick-on Weight (yellow, rectangular) indicators to correspond to the Weight Mode selected.

### 6. Mode Indicators

These indicate specific operating states:

- 6a. Standard/Fine accuracy
- 6b. Automatic/Manual wheel dimensions
- 6c. Matching indicator.

### 7. MM Indicator

Illuminated constantly when millimeters are selected as rim diameter units.

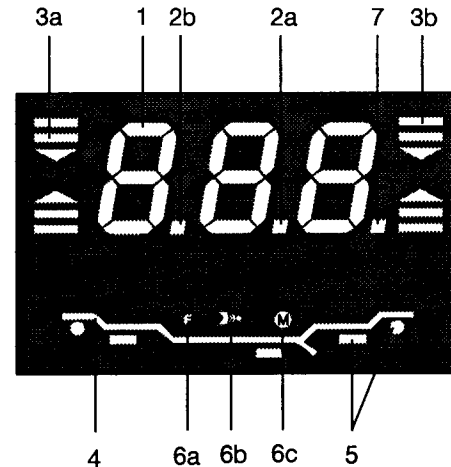



## Input Panel

The input panel contains controls, positioned for convenience, with graphical symbols clearly defining each function.

The input panel is used to select specific operating states and to enter data for the wheel to be balanced and the weights to be used.

### 1. Fine

Used in any mode to balance a wheel to within 0.10 ounces/2 grams (rather than the normal 0.25 ounces/ 5 grams).

### 2. Mode

Selects the Weight Mode. The mode selected is indicated by the weight mode indicators on the rim profile in the display panel. The balancer automatically recalculates the weights and positions for balancing the wheel when a new weight mode is selected without the need to re-spin the wheel.

### 3. Match

Used to start the Optimatch (Tire and Rim Matching) programme. Press Mode to exit the Optimatch programme.

### 4. Auto

This selects Automatic Dimensions mode. Press again to return to Manual Dimensions.

### 5. Left Arrow

### 6. Right Arrow

### 7. Enter

These are used to program dimensions manually and to select Two-Button functions.

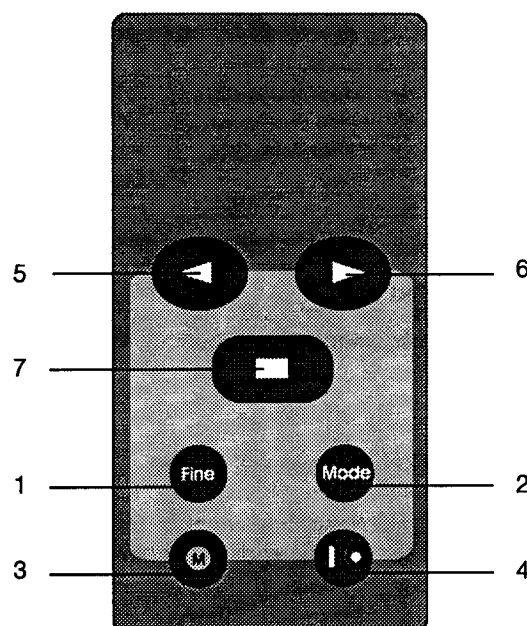

## TWO-BUTTON FUNCTIONS

Press and hold both buttons together for 1 second:

### *Left Arrow + Right Arrow (5 + 6)*

Changes wheel diameter units from inches to millimeters or vice-versa.

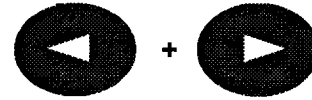

### *Left Arrow + Match (5 + 3)*

Changes weight units from ounces to grams or vice-versa.



### *Left Arrow + Auto (5 + 4)*

Start Automatic Dimensions (Frame) Calibration programme.



### *Left Arrow + Fine (5 + 1)*

Start Automatic Weight Calibration programme.



### *Right Arrow + Match (6 + 3)*

Used to enable or disable Matching Recommended indication.



## Measuring Frame

In Automatic mode, the rim diameter, rim width and rim offset are measured and programmed automatically when the measuring frame is lowered. Lowering the measuring frame also activates the motor and spins the wheel up to measuring speed. When the wheel reaches measuring speed, the motor disengages. The frame is raised after the measuring cycle is completed, when the brake has been automatically applied. If the frame is raised before the measuring cycle is completed, the brake engages and an error message is displayed.

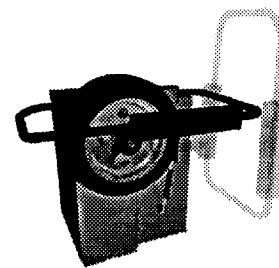

## Offset Scale

Offset, or rim distance, is a measurement of where the wheel is mounted relative to the body of the balancer. The offset scale measures this distance when wheel dimensions are being entered manually. The offset scale is located at the top rear of the head. The offset value is read at the point where the scale arm enters into the housing. This value is entered with the Arrow and Enter buttons on the input panel. The scale is spring-loaded and will return to its resting position when released.

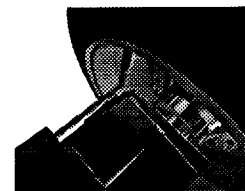

### Calipers

The calipers are used to measure the width of the rim of the wheel being balanced when wheel dimensions are being programmed manually. The width is then programmed with the Arrow and Enter buttons on the input panel. The calipers are stored on a peg at the side of the machine.

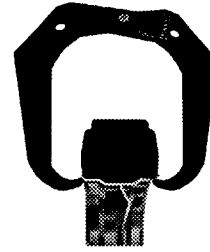

### Storage Pegs

These are situated on the side and rear of the display support and provide locations for storing wheel mounting cones and other accessories.

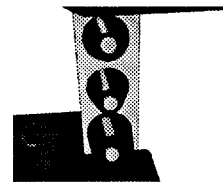

### Weight Tray

This moulded tray contains compartments for weights and storage areas for weight pliers and accessories.

## BALANCING OPERATION

CWB 1858 operation to balance a wheel is based upon a short sequence of actions which are intuitive, efficient and simple.

### Operating Procedure

The following summary covers the main steps for fast, accurate wheel balancing with the CWB 1858. Later sections of this manual contain more detailed information on weight location modes and wheel mounting methods for your balancer.

#### 1. Mount the wheel.

Select the accessories appropriate to the method of wheel mounting to be used (refer to the *Wheel Mounting Methods* section).

Careful wheel mounting is essential, as the wheel is balanced relative to how well it is mounted on the balancer. If the wheel is not well centered and sitting squarely against the balancer flange plate, accurate balance results will not be achieved.

Most stud-centered wheels have concentric center holes, which allow fast and easy cone mounting. Adaptors should be used only in problem situations and on some aftermarket specialty wheels.

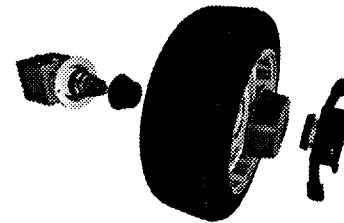

#### 2. Select Weight Mode (if necessary).

Press Mode on the input panel to set the Weight Mode Indicators on the rim profile for the types and locations of weights to be used to balance the wheel.

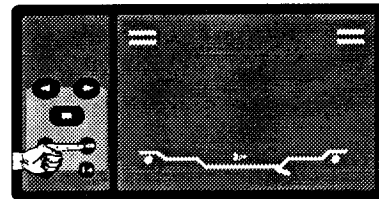

#### 3. Select Fine Mode (if necessary).

Press Fine if the wheel is to be balanced to within 0.10 ounces/2 grams. The Fine indicator will be lit on the display panel. Press Fine again to reset the standard 0.25 ounces/5 grams. Fine Mode may also be set or cleared after the measuring cycle is over and the results displayed; new results will be automatically recalculated.

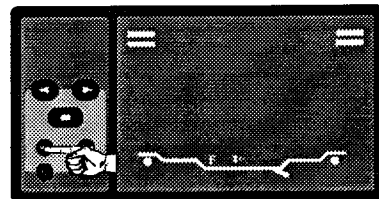

## BALANCING OPERATION

CWB 1858 operation to balance a wheel is based upon a short sequence of actions which are intuitive, efficient and simple.

### Operating Procedure

The following summary covers the main steps for fast, accurate wheel balancing with the CWB 1858. Later sections of this manual contain more detailed information on weight location modes and wheel mounting methods for your balancer.

#### 1. Mount the wheel.

Select the accessories appropriate to the method of wheel mounting to be used (refer to the *Wheel Mounting Methods* section).

Careful wheel mounting is essential, as the wheel is balanced relative to how well it is mounted on the balancer. If the wheel is not well centered and sitting squarely against the balancer flange plate, accurate balance results will not be achieved.

Most stud-centered wheels have concentric center holes, which allow fast and easy cone mounting. Adaptors should be used only in problem situations and on some aftermarket specialty wheels.

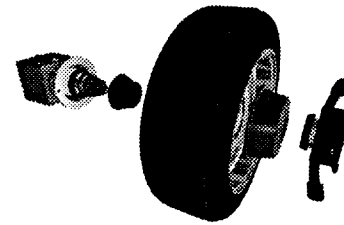

#### 2. Select Weight Mode (if necessary).

Press Mode on the input panel to set the Weight Mode Indicators on the rim profile for the types and locations of weights to be used to balance the wheel.

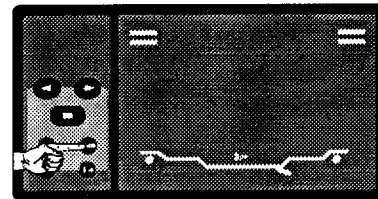

#### 3. Select Fine Mode (if necessary).

Press Fine if the wheel is to be balanced to within 0.10 ounces/2 grams. The Fine indicator will be lit on the display panel. Press Fine again to reset the standard 0.25 ounces/5 grams. Fine Mode may also be set or cleared after the measuring cycle is over and the results displayed; new results will be automatically recalculated.

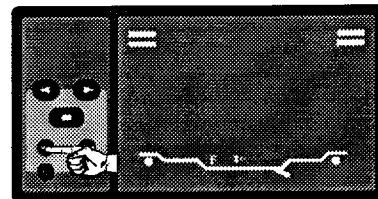

In Automatic mode (Auto indicator lit) skip to step 7 (there is no need to program the wheel dimensions.)

To set Automatic mode if the Auto indicator is not lit, press Auto on the input panel.

OR

To balance in Manual Mode, press Enter. The green Auto indicator will not be lit. (Proceed through Steps 4 to 6.)

4. Program the Rim Diameter.

The display shows 2 red weight position indicators illuminated on the inner side and a value on the numeric display. Read the wheel diameter, in inches or millimeters, from the tire sidewall.

Press the Left Arrow button to lower the value and press the Right Arrow button to raise the value, and the numeric display will change. When the correct value appears, press Enter to input the diameter.

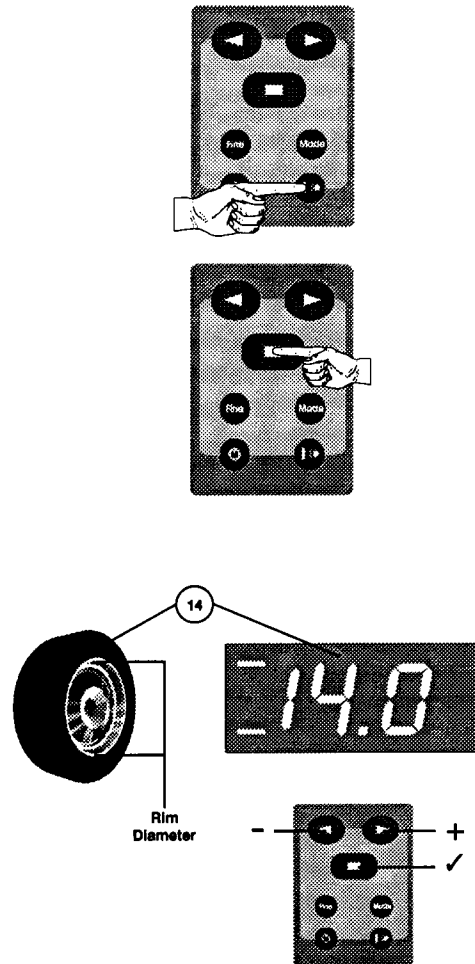

5. Program the Rim Width.

The display shows 1 red weight position indicator illuminated on both the inner side and outer side, and a value on the numeric display. Measure the width of the rim using the calipers - read the width, in inches, from the scale on the calipers.

Press the Left Arrow button to lower the value and press the Right Arrow button to raise the value, and the numeric display will change. When the correct value appears, press Enter to input the width.

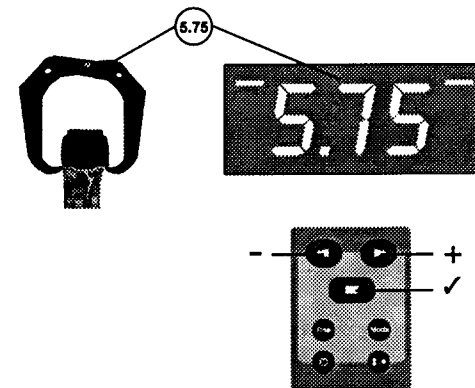

### 6. Program the Rim Offset.

The display shows 1 red weight position indicator illuminated on the inner side and a value on the numeric display. Pull the offset scale out and position the tip against the rim flange surface of the wheel. (regardless of where the inner weight will be placed). Read the offset value off the scale at the point where it enters into the housing.

Press the Left Arrow button to lower the value and press the Right Arrow button to raise the value, and the numeric display will change. When the correct value appears, press Enter to input the offset.

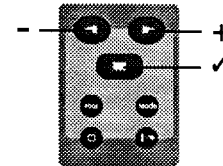
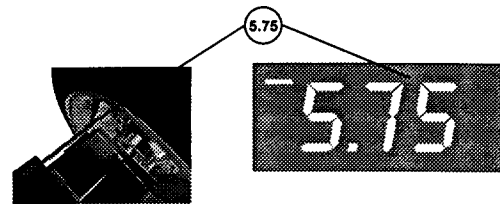

### 7. Spin the wheel.

**MOTOR-SPIN:** Lower the frame to start the motor which will automatically spin the wheel up to measuring speed. In Automatic Mode, the dimensions of the wheel are scanned as the frame is lowered.

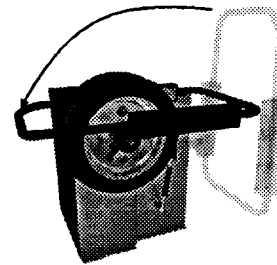

OR

**HAND-SPIN:** This method is only valid in Manual mode. Using the hub nut handle, turn the wheel clockwise until the balancer beeps, then release the handle. The wheel will continue to rotate for the duration of the measuring cycle. If the wheel is spun too fast, the beeps will sound continuously until the wheel slows to the proper measuring speed and the balancer can perform its measuring cycle as normal.

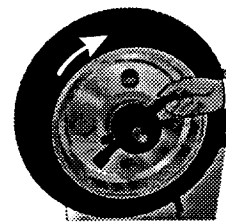

**Do not interfere with the balancer or with the wheel during the measuring cycle as wrong results may occur.**

When the measuring cycle is complete, the brake is automatically applied to slow the wheel. Raise the frame if the wheel was not hand-spun.

#### 8. Attach the weights.

Starting with either side of the wheel, rotate the wheel until all 6 weight position indicators for that side of the wheel are lit. The correct balance weight will now be displayed.

Apply the displayed weight securely at the Top-Dead-Center (12 o'clock) position on the wheel. Repeat these steps for the other side of the wheel.

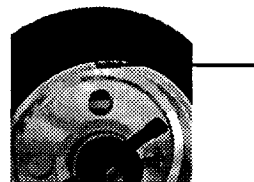

#### 9. Do a check spin.

Spin the wheel again (Step 7). The display should indicate a balanced wheel by showing '000' constantly (i.e. regardless of wheel position).



**At this point, Fine Mode may be set or cleared, the Weight Mode may be changed, or the wheel dimensions (diameter, width, offset) may be altered. The balancer will automatically recalculate the correct results for the new settings without the need to re-spin the wheel.**

### Entering Dimensions in Manual Mode

The following points should be noted:

- If the wheel diameter units are set to millimeters, the diameter value displays as 'mmm'. Pressing the Left Arrow and Right Arrow changes the diameter to the next standard millimetric diameter value.
- If the CTS weight location mode is selected, the rim diameter is automatically shown in millimeters, from a table of CTS rim diameters.
- In Alu 3 and Alu 4 weight location modes, the width is fixed at 4.00".
- In Special weight location mode, the inner and outer diameters will change in increments of 0.25" rather than 1.0".



## Balancing Errors

The CWB 1858 wheel balancer is equipped with a Diagnostic Self-Test program which automatically tests the internal electronics and cabling of the balancer every time the power is turned on. It also detects errors during operation if the procedure is carried out incorrectly. An error code is displayed for 3 seconds and the balancer beeps twice when such errors occur.

Each error code is specific to a type of error ensuring that the cause of a fault or incorrect action may be quickly established. If a failure is reported, record the error code and switch off the machine. Turn on the machine again after 5 seconds and check if the error code remains. If the fault persists, report the error code to your service representative.

If the wheel is intentionally or accidentally slowed or stopped during the measuring cycle, the display will report an error. Spinning the wheel up to balancing speed again will remove this error and allow the balancer to function normally.

If repeatable results cannot be achieved, there is a possibility of foreign material moving around inside the tire and causing a different imbalance every time. This material must first be removed before the wheel can be balanced.

If readings appear to be inconsistent or additional weights are continually called for, verify that the wheel is not slipping on the flange when the brake is applied.

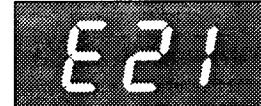

## WEIGHT MODES

The CWB 1858 features one Normal weight mode for clip-on weights only, four Alu weight modes for combinations of clip-on and stick-on weights and a CTS weight mode for the Continental Tire System wheels. In addition, static weight mode is for static balancing where a single weight is to be applied.

Pressing Mode on the input panel sequences through the weight modes. The Weight Mode indicators on the rim profile indicate the selected weight types and placements.

When attaching the weights, observe the placement dimensions shown in the diagrams for each mode. The balancer is programmed for these dimensions; other placement locations will require different weights.

For simple and accurate balancing, the Normal weight mode may be used for all balancing measurements. After the balancing cycle, use Mode on the input panel to set the required weight mode. The balancer will automatically recalculate the weights required for the new weight mode.

On the rim profile, clip-on weights are indicated by green, circular lights; stick-on weights are indicated by yellow, rectangular lights.

*Normal*: Standard clip-on weights are applied, one to each of the inner and outer rim flanges.

*Alu 1*: A standard clip-on weight is applied on the inner rim flange. A stick-on weight is used on the outer bead seat of the rim.

*Alu 2*: Stick-on weights are applied, one on the inner and the second on the outer bead seat areas of the rim.



**Alu 3** : A standard clip-on weight is used on the inner rim flange and a stick-on weight is applied towards the center area of the rim. This is a 'hidden-weight' technique - the weights should not be visible when the wheel is replaced on a car.

**Alu 4** : This is another 'hidden-weight' method. One stick-on weight is applied on the inner bead seat area and a second stick-on weight is applied towards the center area of the rim.

When using the Alu 3 or Alu 4 Modes, the inner and outer weights **MUST** be placed the correct distance apart longitudinally (dimension "D"). The balancer is programmed for this distance when using these weight modes. If it is necessary to use weight placements not catered for in the section, refer to the *Special Applications* section.

**CTS** : This weight mode is only available in Manual mode. In this weight mode, the same stick-on weight indicators as set in Alu 2 are lit. The weights should be placed in the grooves on the inner and outer wheel-well areas as shown opposite. Use the rim diameter as shown on the tire sidewall (millimetric) to program the balancer.

**Static Balancing** : Only one stick-on weight indicator is lit; however, either a single clip-on or stick-on weight may be used. The weight can be positioned on the inner or outer rim flange, or towards the center of the rim. If the imbalance is large, the amount of weight required can be divided equally between the inner and outer rim flanges.

For static balancing, the rim width and offset dimensions do not need to be entered into the balancer. Only the wheel diameter must be programmed. After the measuring cycle, the inner (left) weight position indicators will be used to indicate the TDC position for the static balancing weight (the outer indicators will not display).

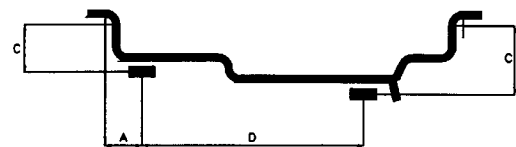
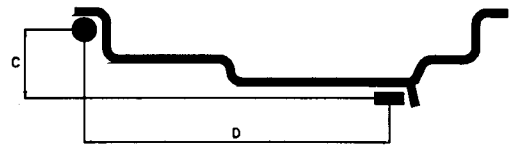

- A = 0.5"/1.25cm
- B = 0.75"/2cm
- C = 1.5"/4cm
- D = 4.0"/10cm

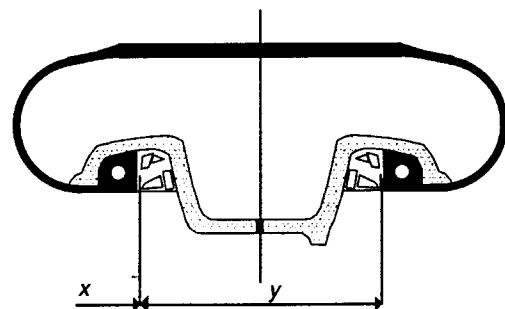

## Special Applications

Occasionally it may be necessary to use weight locations which are different from those used in the standard Alu programmes. This will usually only occur for hidden weight methods, where the distance between the weights of 10 cm (4") is not suitable. If situations are encountered where special weight locations are required proceed as follows:-

1. Select Special weight mode.

Ensure the balancer is in Special mode. Press Mode on the input panel repeatedly until the two clip-on and two stick-on weight mode indicators flash alternately.

2. Program the diameter.

Use the Arrow and Enter buttons on the input panel to set the diameters at which the hidden weights will be applied. Firstly, program the Inner diameter and press Enter to select. Repeat for the Outer diameter. These diameters may be specified to the nearest 0.25".

3. Program the width.

Measure the distance between the two locations A and B where the weights will be applied. If weight B is a hidden weight use a tape measure or rule. If weight B is on the outer rim, the calipers can be used. Use the Arrow and Enter buttons on the input panel to set the width.

4. Program the offset.

Pull the offset scale out and position the tip at the point where the inner weight is to be located. Read the offset value from the scale, use the Arrow and Enter buttons on the input panel to set the offset.

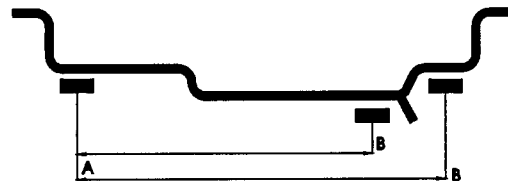
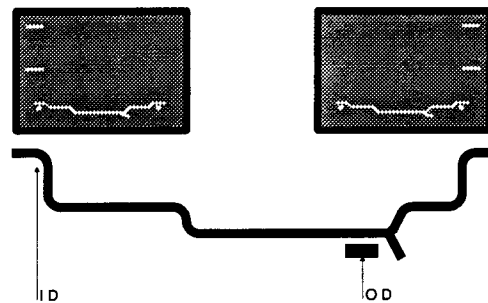

5. Spin the wheel.

Complete normal balance routine.

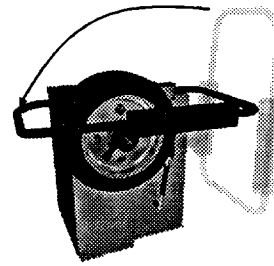

6. Attach the weights.

Rotate the wheel until the TDC position on either side of the wheel is reached. Attach the displayed weight amount at the TDC (12 o'clock) position. Repeat this procedure for the other side of the wheel.

**If the weights are not attached at the correct locations (as measured), accurate balance results will not be achieved.**

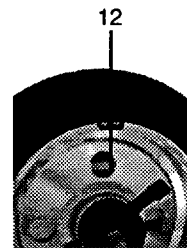

7. Do a check spin.

Repeat the normal balancing routine. The display should indicate a balanced wheel by showing '0.00' constantly (i.e. regardless of wheel position).



## WHEEL MOUNTING METHODS

### Back Cone Mounting

Back cone mounting is the most common way to mount automobile wheels. Choose the cone that fits best when placed through the wheel center hole from the rear. Slide the cone spring and cone on the shaft. Place the wheel on the cone and be sure that the cone centers the wheel when you tighten the handle.

The pressure drum should contact the wheel on a flat surface. Do not center the wheel with the pressure drum. Tighten the wheel firmly against the mounting flange. Hold the handle in place and rotate the wheel when tightening. Be sure that the wheel is firmly against the mounting flange and the handle threads engage at least three turns on the shaft.

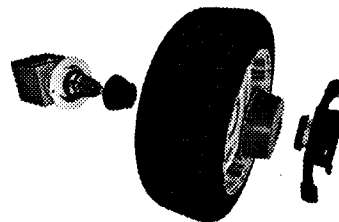

### Front Cone Mounting

Front cone mounting is required when using light truck wheels and is also an acceptable alternative for many automobile wheels. The wheel center hole must be true on the outside of the wheel to use the front cone mounting method.

Choose the cone that fits best when placed through the wheel center hole from the front. Slide the wheel on the balancer shaft without a back cone or spring on the shaft. Place a cone on the shaft, through the front of the wheel. Be sure the cone centers the wheel and that the wheel is squarely against the mounting flange when you tighten the handle.

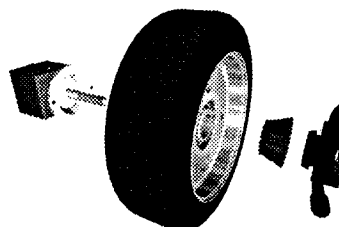

### Back Cone Mounting without Pressure Drum

Ensure the handle does not contact the cone, or the wheel will not be centered and mounted securely. Attach the spacer ring to the hub nut if this situation occurs.

**On some extended-center wheels with small hub diameters, the pressure drum cannot contact the front face of the wheel properly. Such wheels can be mounted using the standard back cone method without a pressure drum. Check that the handle contacts the wheel center evenly and that the wheel is centered on the cone.**

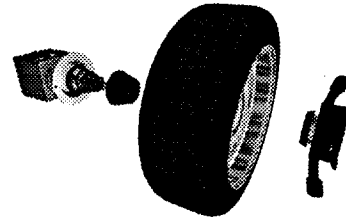

### Double Cone Mounting

The cones must not touch each other. If the cones touch, the wheel will not be centered and mounted securely.

**Double cone mounting can be used for some specialty wheels, such as those on a Porsche 928. The back cone centers on the formed part of the wheel, and the front cone centers on the hole.**

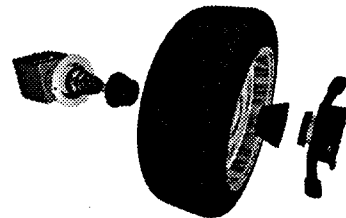

### Front Cone Mounting with an Extension Adaptor

The extension adaptor may be required for some light truck wheels and reverse-offset wheels that must be moved away from the balancer mounting flange. The extension adaptor is often used with the 5-1/2-inch diameter light truck cone.

Install the extension adaptor on the mounting flange with the knurled thumbnuts provided. Then mount the wheel, using the normal front cone method.

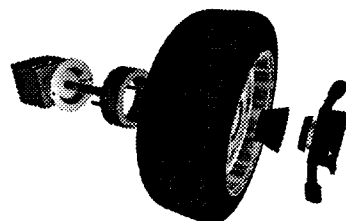

### Universal Wheel Adaptor

This adaptor is used on wheels with untrue center holes and wheels with closed centers or for any application where automotive mounting cones can not be used. Instructions for use are supplied with the adaptor.



### Metric Bolt Plate Adaptor

The metric bolt plate adaptor is an alternative to the universal wheel adaptor. The adaptor is used on wheels with untrue center holes, wheels with closed center holes as found on many French vehicles, or where the wheel is centered on the wheel mounting studs rather than by conical wheel mounting nuts. Instructions for use are supplied with the adaptor.



### Wheel Mounting Errors

Regardless of the mounting method used, the wheel must be centered before balancing. A wheel should be mounted on the appropriate cone or adaptor and tightened carefully to ensure proper centering and mating against the balancer flange.

The wheel must be clean and free of large burrs or nicks, especially where it mates with the cone or adaptor and the balancer flange. Any dirt between the flange and the mating surface of the wheel will cause misalignment on the shaft. A misalignment of the thickness of a matchbook cover will cause an unbalance of 0.50 ounces (15 grams) or more on automobile wheels and 1 ounce (30 grams) on light truck wheels.

The wheel must also be tightened securely to prevent it from slipping in relation to the flange. If the wheel slips on the balancer, accurate weight measurement and location are impossible.



## OPTIMATCH TIRE AND RIM MATCHING

Wheel balancing may sometimes be improved by matching the tire to the rim of the wheel. The Optimatch programme matches the rim imbalance (heavy spot) and rim runout against the tire imbalance and runout. Wheel vibrations due to out-of-round conditions and hard or soft spots in the rim or tire, can be reduced by matching.

The CWB 1858 provides an option which informs the user after a spin cycle that balancing may be further improved by using the Optimatch programme. If this option is selected, the green Matching Indicator flashes 5 times. This option is selected (or deselected) by pressing the Right Arrow (>) and Match on the input panel for 1 second.

### Matching Symbols

The following symbols are used in the display during the Optimatch programme, to indicate modes and further instructions for use.

a) Rim-Only



b) Rim+Tire

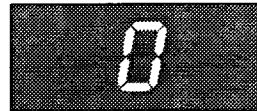

c) Move the valve to the 12 o'clock position



d) Any time the "M" flashes, press the Match button on the input panel.

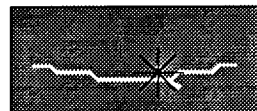

e) Spin the wheel



## Starting the Matching Procedure

To start the Optimatch programme, press Match on the input panel. The balancer will beep and the Rim-Only indicator will light.

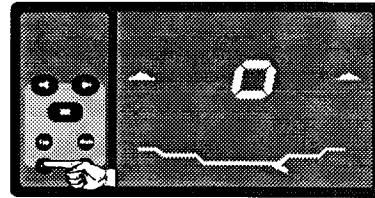

To exit the Optimatch programme at any time, press Mode on the input panel. The balancer will return to normal dynamic balancing.

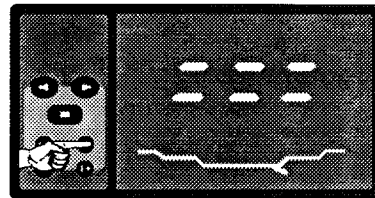

If you are starting with the rim only mounted on the balancer, proceed to the Starting with Rim Only section.

If you want to start with the tire on the rim, press either the Left Arrow (<) or the Right Arrow (>) on the input panel. The Rim+Tire indicator will be displayed instead of the Rim-Only indicator. Proceed to the Starting with Rim+Tire section.

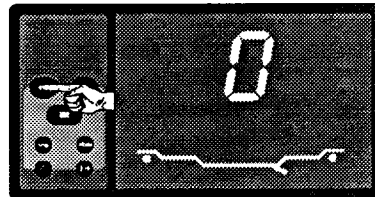

The CWB 1858 automatically exits from the Optimatch programme after a spin cycle, if it calculates that matching would not further improve balancing. This occurs when:

- a) The rim has only a small imbalance.
- b) The rim+tire combination has only a small imbalance (ie. the rim and tire heavy spots are already in the best position for matching).

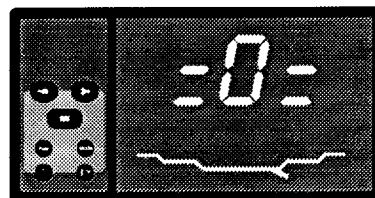
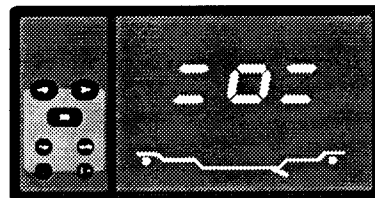

## Starting with Rim Only

1. Ensure that the Rim-Only indicator is displayed. Mount the rim on the balancer and spin.

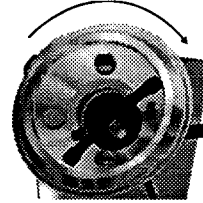
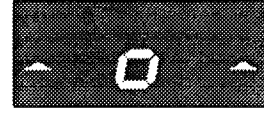

2. After the rim is spun, the green Matching indicator flashes and the balancer beeps. Move the valve to the TDC (12 o'clock) position.

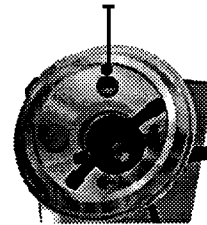
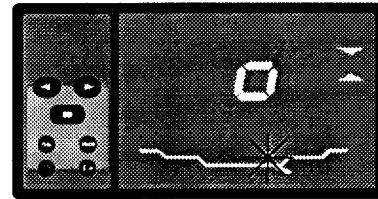

3. With the valve at TDC, press Match on the input panel. The Matching indicator is turned off and the Rim+Tire indicator is displayed.

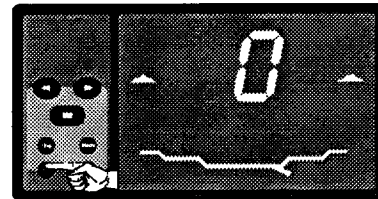

4. Dismount the rim and fit the tire to the rim.

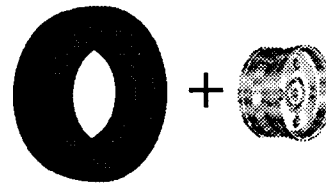

5. Mount the rim with tire on the balancer and spin.

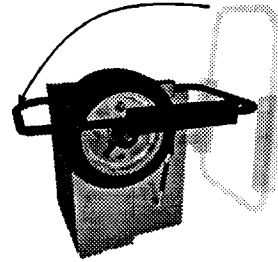

6. When the wheel stops, the green Matching indicator flashes and the balancer beeps. Move the valve to the TDC (12 o'clock) position.

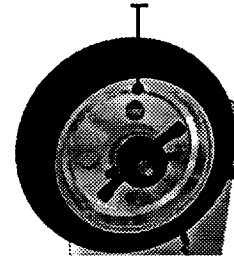
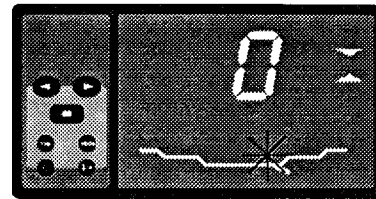

7. With the valve at TDC, press Match on the input panel. The Matching indicator goes out.

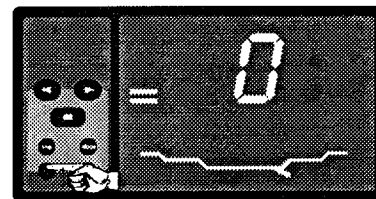

8. Rotate the rim with tire until the numeric display reads "-0-". The Matching indicator flashes and the balancer beeps.

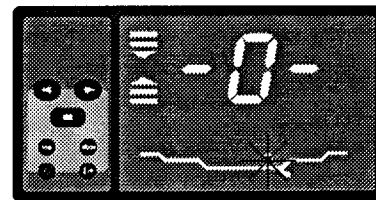

9. Mark an 'X' on the tire at the TDC (12 o'clock) position. Press Match on the input panel.

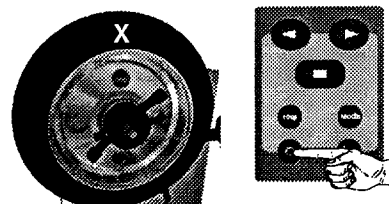

10. The Matching indicator goes off and the display shows " = = =" for a few seconds.

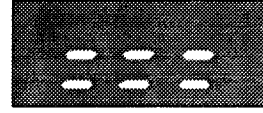

11. Rotate the tire on the rim until the 'X' on the tire is aligned with the valve on the rim.

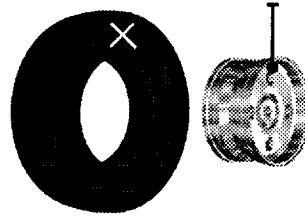

The procedure is now complete and the balancer has exited the Optimatch programme. Normal balancing operation may be resumed.

### Starting with Rim plus Tire

1. Ensure the Rim+Tire indicator is displayed. The Matching indicator flashes and balancer beeps.

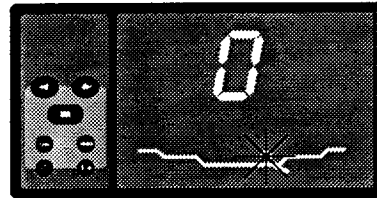

2. Mark a line on the tire at the valve. Press Match on the input panel and the Matching indicator goes out.

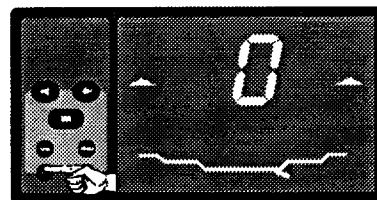
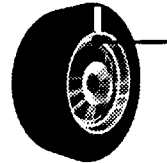

3. Mount the rim with tire on the balancer and spin.

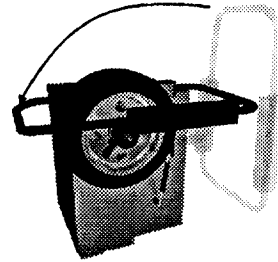

4. The Matching indicator flashes and the balancer beeps. When the wheel stops move the valve to the TDC (12 o'clock) position.

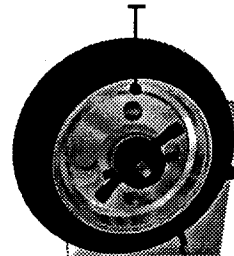
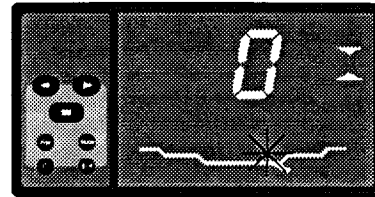

5. Press Match on the input panel. The Matching indicator goes out. The Rim+Tire indicator is turned off and the Rim-Only indicator is displayed.

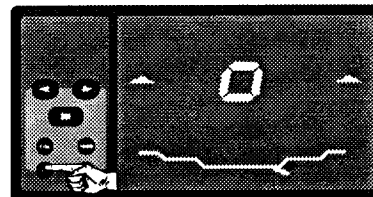

6. Dismount the rim with tire and remove the tire from the rim.

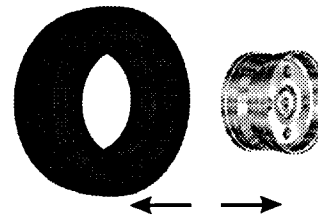

7. Mount the rim only on the balancer and spin.

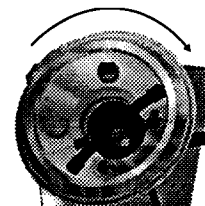

8. The Matching indicator flashes and the balancer beeps. When the rim stops, move the valve to the TDC (12 o'clock) position.

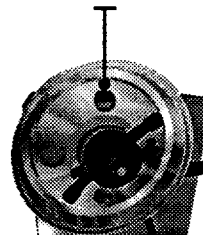
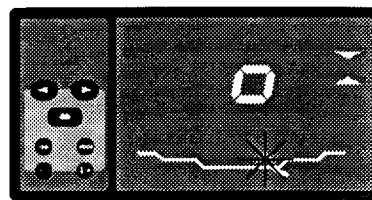

9. Press Match on the input panel. The Matching indicator is turned off.

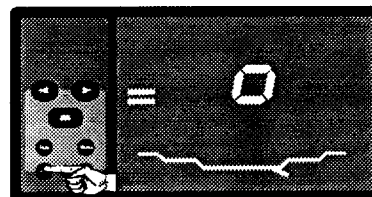

10. Rotate the rim until the numeric display reads "-o-". The Matching indicator flashes and the balancer beeps.

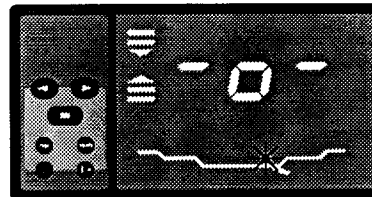

11. Mark an 'X' on the rim at the TDC (12 o'clock) position. Press Match on the input panel.

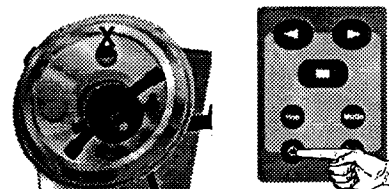

12. The Matching indicator goes off and the display shows " = = =" for a few seconds.

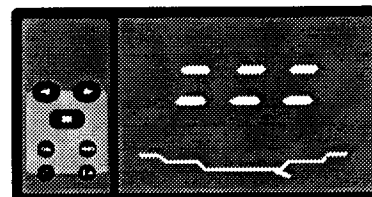

8. The Matching indicator flashes and the balancer beeps. When the rim stops, move the valve to the TDC (12 o'clock) position.

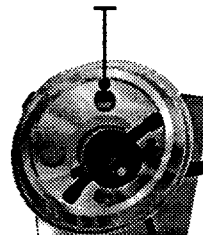
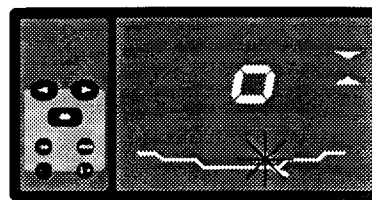

9. Press Match on the input panel. The Matching indicator is turned off.

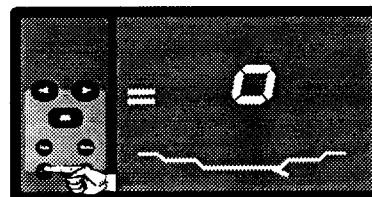

10. Rotate the rim until the numeric display reads "-o-". The Matching indicator flashes and the balancer beeps.

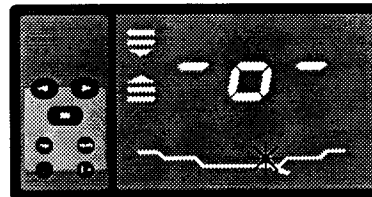

11. Mark an 'X' on the rim at the TDC (12 o'clock) position. Press Match on the input panel.

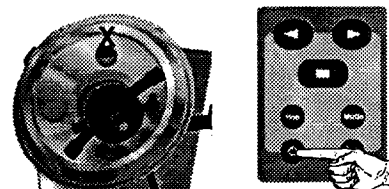

12. The Matching indicator goes off and the display shows " = = =" for a few seconds.

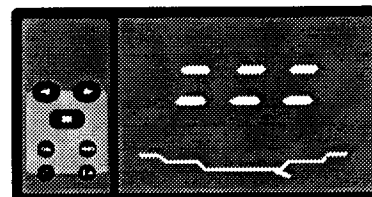



13. To match the rim to the tire:

- a) Superimpose the rim to the tire, ensuring that the line marked on the tire is aligned with the valve on the rim.
- b) Mark an 'X' on the tire adjacent to the 'X' on the rim.
- c) Fit the tire to the rim with the 'X' on the tire aligned with the valve on the rim.

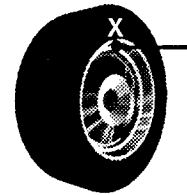
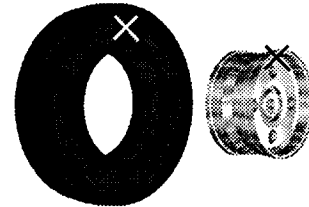
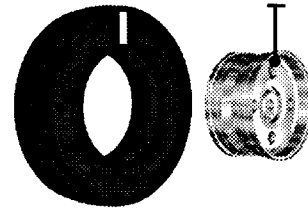

The procedure is now complete and the balancer has exited the Optimatch programme. Normal balancing operation may be resumed.

## 4. CALIBRATION

Each balancer is calibrated by computer before shipment from the factory to ensure accuracy of measurements. There should be no requirement to recalibrate in normal service. However, the balancer may need to be calibrated again if :

- The electronics assembly or the sensors have to be replaced.
- The PCB Door assembly has to be replaced.
- The Back Pannel assembly has to be replaced.
- The Measuring Head assembly have to be replaced.
- The measuring frame has been replaced.
- Balancing results appear to be irregular or inconsistent.

The balancer has built-in Calibration programmes which require only a few simple steps and can be performed in about the same time as it takes to balance a single wheel.

### 4.1 Weight Calibration Procedure

#### 1. Fine-balance the wheel in Manual mode.

It is advisable to use a wheel of a size similar to those most commonly balanced (for example, a 14" wheel). Mount the wheel carefully. Press Enter on the input panel and program the wheel dimensions. Set Normal weight mode.

Balance the wheel to '0.00' in Fine Mode.

#### 2. Attach the Calibration weight.

If weights are displayed in ounces, a 3-ounce weight must be used for calibration. If weights are displayed in grams, then a 100-gram weight must be used. With the balancer displaying '0.00' constantly for a balanced wheel, rotate the wheel until all outer weight location indicators are lit. Attach the weight to the outer wheel rim at the TDC (12 o'clock) position.3. Start the Weight Calibration programme.

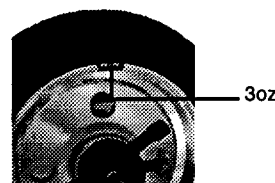
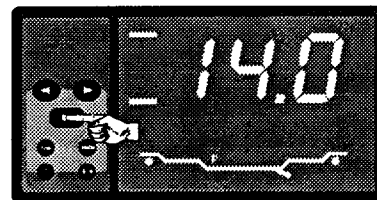

To start the Weight Calibration Programme, press and hold the Left Arrow and then press and hold Fine on the input panel. Keep both buttons pressed for 1 second. The balancer will beep and a flashing 'ccc' will appear on the numeric display. Only the outer green clip-on weight on the rim profile is illuminated.

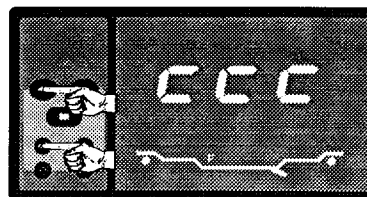

#### 4. Spin the wheel.

Lower the frame to motor-spin the wheel, or hand-spin the wheel. The balancer will beep and perform a measuring cycle. The brake will be automatically applied at the end of the cycle.

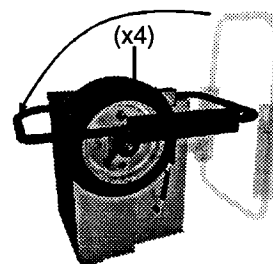

#### 5. Repeat wheel spins.

A minimum of 4 spins are needed for a successful calibration. Another spin is required when the balancer displays a flashing 'ccc' after a measuring cycle.

#### 6. End of Calibration.

When calibration is completed successfully (no more spins required), the display will show the calibration weight value - '3.00' or '100'. This value will be displayed for all wheel positions except when the wheel is rotated to the inner light spot, when '0.00' will be displayed.

After successful calibration, the balancer stores the new calibration values in memory. These new calibration values will be retained even when the power is switched off.

If you wish to quit the Weight Calibration procedure without completion, press Mode on the input panel.



### Frame Calibration Procedure

1. Press the Left Arrow and then press Auto on the input panel. Keep both buttons pressed for 1 second. The balancer will beep and '\_FFF\_' will be displayed.

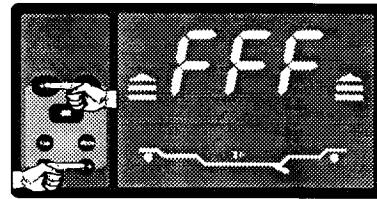

2. Raise the frame to the fully upright position.

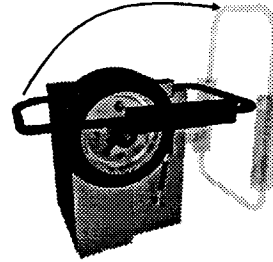

3. Press the Enter on the input panel. The balancer will beep and the display will change to 'FFF'.

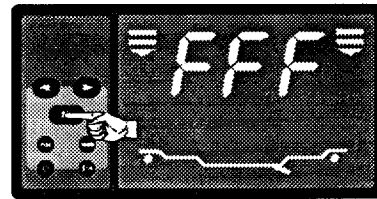

4. Lower the frame to the fully horizontal position.

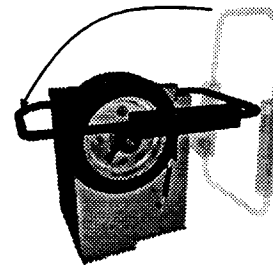

5. Press Enter on the input panel. The balancer will beep and the display will change to '000'. (the motor will NOT start during Frame Calibration).

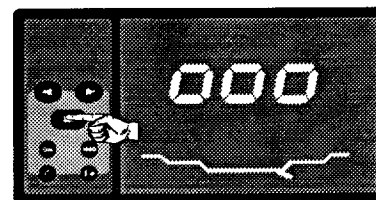

The calibration of the frame is now complete. The display will be cleared after a few seconds. The balancer may now be used normally.

After successful calibration, the balancer stores the new calibration values in memory. These new calibration values will be retained even when the power is switched off.

## 4. CALIBRATION

Each balancer is calibrated by computer before shipment from the factory to ensure accuracy of measurements. There should be no requirement to recalibrate in normal service. However, the balancer may need to be calibrated again if :

- The electronics assembly or the sensors have to be replaced.
- The PCB Door assembly has to be replaced.
- The Back Pannel assembly has to be replaced.
- The Measuring Head assembly have to be replaced.
- The measuring frame has been replaced.
- Balancing results appear to be irregular or inconsistent.

The balancer has built-in Calibration programmes which require only a few simple steps and can be performed in about the same time as it takes to balance a single wheel.

### 4.1 Weight Calibration Procedure

1. Fine-balance the wheel in Manual mode.

It is advisable to use a wheel of a size similar to those most commonly balanced (for example, a 14" wheel). Mount the wheel carefully. Press Enter on the input panel and program the wheel dimensions. Set Normal weight mode.

Balance the wheel to '0.00' in Fine Mode.

2. Attach the Calibration weight.

If weights are displayed in ounces, a 3-ounce weight must be used for calibration. If weights are displayed in grams, then a 100-gram weight must be used. With the balancer displaying '0.00' constantly for a balanced wheel, rotate the wheel until all outer weight location indicators are lit. Attach the weight to the outer wheel rim at the TDC (12 o'clock) position. 3. Start the Weight Calibration programme.

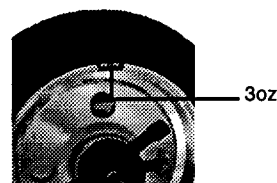
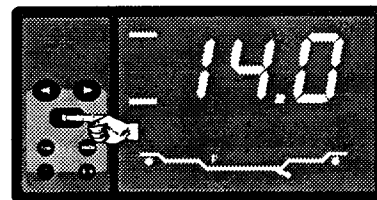

To start the Weight Calibration Programme, press and hold the Left Arrow and then press and hold Fine on the input panel. Keep both buttons pressed for 1 second. The balancer will beep and a flashing 'ccc' will appear on the numeric display. Only the outer green clip-on weight on the rim profile is illuminated.

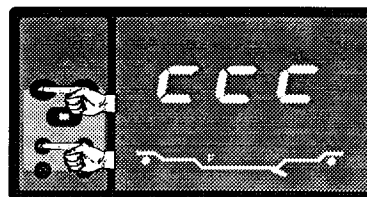

#### 4. Spin the wheel.

Lower the frame to motor-spin the wheel, or hand-spin the wheel. The balancer will beep and perform a measuring cycle. The brake will be automatically applied at the end of the cycle.

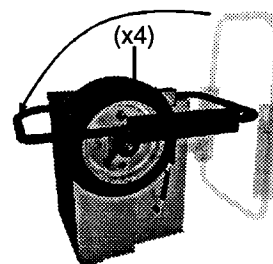

#### 5. Repeat wheel spins.

A minimum of 4 spins are needed for a successful calibration. Another spin is required when the balancer displays a flashing 'ccc' after a measuring cycle.

#### 6. End of Calibration.

When calibration is completed successfully (no more spins required), the display will show the calibration weight value - '3.00' or '100'. This value will be displayed for all wheel positions except when the wheel is rotated to the inner light spot, when '0.00' will be displayed.

After successful calibration, the balancer stores the new calibration values in memory. These new calibration values will be retained even when the power is switched off.

If you wish to quit the Weight Calibration procedure without completion, press Mode on the input panel.



### Frame Calibration Procedure

1. Press the Left Arrow and then press Auto on the input panel. Keep both buttons pressed for 1 second. The balancer will beep and '\_FFF\_' will be displayed.

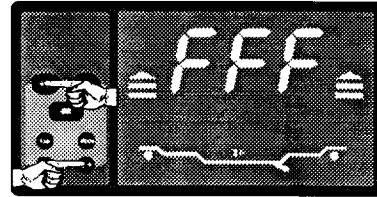

2. Raise the frame to the fully upright position.

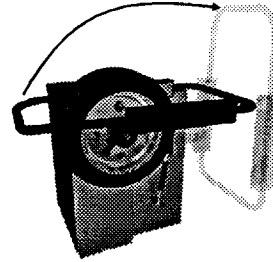

3. Press the Enter on the input panel. The balancer will beep and the display will change to 'FFF'.

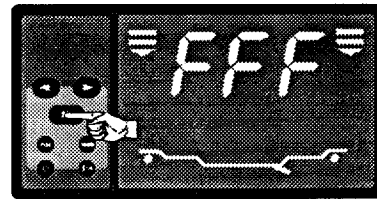

4. Lower the frame to the fully horizontal position.

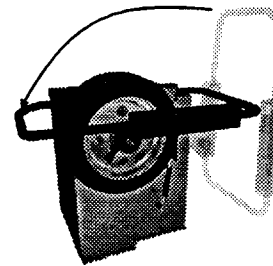

5. Press Enter on the input panel. The balancer will beep and the display will change to '000'. (the motor will NOT start during Frame Calibration).

The calibration of the frame is now complete. The display will be cleared after a few seconds. The balancer may now be used normally.

After successful calibration, the balancer stores the new calibration values in memory. These new calibration values will be retained even when the power is switched off.

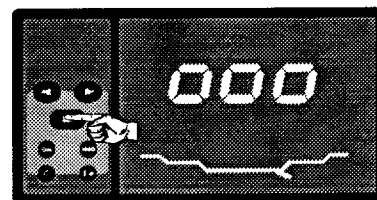

If you wish to quit the Frame Calibration procedure before completion, press Mode on the input panel. The original calibration values will be retained.

### Frame Calibration Errors

If an error occurs during Frame Calibration, the balancer displays error codes on the display. Such errors are described below.

- Frame has not been raised to the fully upright position (when it should have been raised fully).
- Frame has not been moved (when it should have been lowered fully).
- Frame has not been lowered to the fully horizontal position.
- The Frame Encoder which measures frame movement has failed.
- The Frame Encoder which measures frame movement has slipped from its factory-set position.
- The new Calibration Information could not be stored permanently in the balancer.

Each of these error codes will disappear after a few seconds from the display and the balancer will start again at the beginning of the Frame Calibration Procedure.

Repeat the steps of the Frame Calibration Procedure above, or press Mode on the input panel to quit the Frame Calibration Procedure.

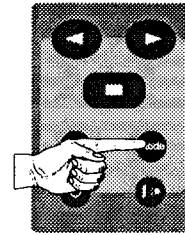

E42

E43

E44 E45 E46

E47

E48

E49



If you wish to quit the Frame Calibration procedure before completion, press Mode on the input panel. The original calibration values will be retained.

### Frame Calibration Errors

If an error occurs during Frame Calibration, the balancer displays error codes on the display. Such errors are described below.

- Frame has not been raised to the fully upright position (when it should have been raised fully).
- Frame has not been moved (when it should have been lowered fully).
- Frame has not been lowered to the fully horizontal position.
- The Frame Encoder which measures frame movement has failed.
- The Frame Encoder which measures frame movement has slipped from its factory-set position.
- The new Calibration Information could not be stored permanently in the balancer.

Each of these error codes will disappear after a few seconds from the display and the balancer will start again at the beginning of the Frame Calibration Procedure.

Repeat the steps of the Frame Calibration Procedure above, or press Mode on the input panel to quit the Frame Calibration Procedure.

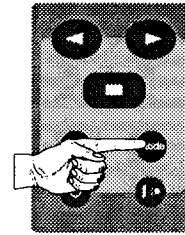

E42

E43

E44 E45 E46

E47

E48

E49

## SERVICE AND MAINTENANCE

The CWB 1858 Wheel Balancer can be maintained with a few simple actions performed at regular intervals.

Wheel mounting accessories and the mounting surfaces of the flange and shaft of the balancer need to be cleaned regularly. Grease and oil will accumulate dirt which can cause incorrect balancing readings, and can also act as a grinding compound resulting in premature wear.

Old wheel weights and other material must be removed from under the balancer. The balancer must rest only on the three machine feet.

Ensure that tires, rims, tools or other parts are not left leaning against the body of the balancer.

Clean the display and input panels with a dry cloth.

If the balancer gets physically damaged or broken, use the Spare Parts List provided with the balancer to identify the parts to be replaced.

Always comply with the safety precautions and instructions described at the beginning of this manual.

### Operational Check

1. Attach the power cord. Switch on the balancer.
2. Press Mode several times. The Weight Mode indicators should light corresponding to each weight mode selected. Return to the Normal weight mode.
3. Press Fine to set Fine Mode. The Fine indicator should light. The Auto indicator should also be displayed.

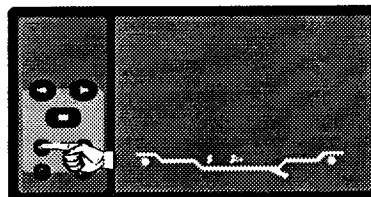
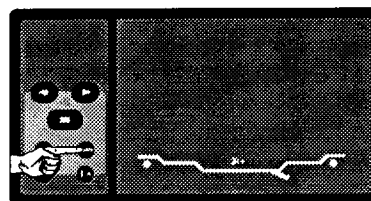
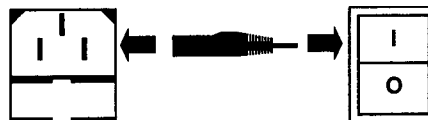

4. Mount a wheel on the balancer. Spin the wheel up to speed by lowering the frame to start the motor. If the motor does not operate, press Auto to change to Manual mode, raise the frame and hand-spin the wheel.

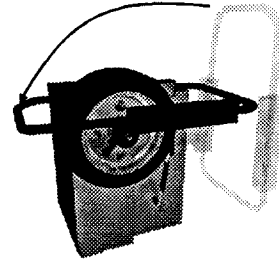

5. Wait until the measuring cycle completes ( 7 seconds) and the brake engages. The brake should stop the wheel smoothly (in 1/2 to 2 revolutions for a standard 14" wheel). The inner and outer weights should be displayed when the wheel is rotated to the respective TDC positions.



6. Fine-balance the wheel to zero.



7. Attach a 3-ounce (100-gram) weight to the outer rim at the 12 o'clock position when all the outer weight indicators are lit. Spin the wheel and note the readings. Repeat with the weight moved to the light spot on the inner rim. The balancer is within calibration limits if the display shows 2.75 - 3.25 ounces (90 - 110 grams) for the side with the weight attached and shows 0 - 0.25 ounces (0 - 10 grams) for the side without the weight. If the readings are not within these limits, verify that the wheel dimensions are set correctly and perform the Weight Calibration procedure, before proceeding to the next step.

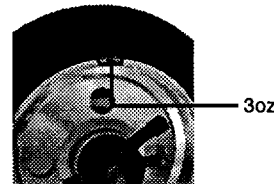

## 4. CALIBRATION

Each balancer is calibrated by computer before shipment from the factory to ensure accuracy of measurements. There should be no requirement to recalibrate in normal service. However, the balancer may need to be calibrated again if :

- The electronics assembly or the sensors have to be replaced.
- The PCB Door assembly has to be replaced.
- The Back Pannel assembly has to be replaced.
- The Measuring Head assembly have to be replaced.
- The measuring frame has been replaced.
- Balancing results appear to be irregular or inconsistent.

The balancer has built-in Calibration programmes which require only a few simple steps and can be performed in about the same time as it takes to balance a single wheel.

### 4.1 Weight Calibration Procedure

#### 1. Fine-balance the wheel in Manual mode.

It is advisable to use a wheel of a size similar to those most commonly balanced (for example, a 14" wheel). Mount the wheel carefully. Press Enter on the input panel and program the wheel dimensions. Set Normal weight mode.

Balance the wheel to '0.00' in Fine Mode.

#### 2. Attach the Calibration weight.

If weights are displayed in ounces, a 3-ounce weight must be used for calibration. If weights are displayed in grams, then a 100-gram weight must be used. With the balancer displaying '0.00' constantly for a balanced wheel, rotate the wheel until all outer weight location indicators are lit. Attach the weight to the outer wheel rim at the TDC (12 o'clock) position.3. Start the Weight Calibration programme.

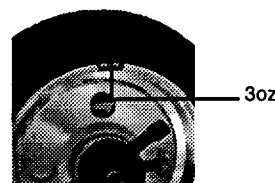
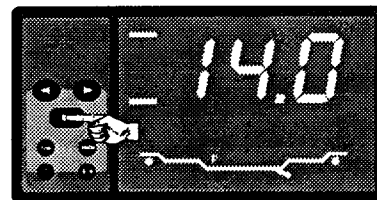

## 4. CALIBRATION

Each balancer is calibrated by computer before shipment from the factory to ensure accuracy of measurements. There should be no requirement to recalibrate in normal service. However, the balancer may need to be calibrated again if :

- The electronics assembly or the sensors have to be replaced.
- The PCB Door assembly has to be replaced.
- The Back Pannel assembly has to be replaced.
- The Measuring Head assembly have to be replaced.
- The measuring frame has been replaced.
- Balancing results appear to be irregular or inconsistent.

The balancer has built-in Calibration programmes which require only a few simple steps and can be performed in about the same time as it takes to balance a single wheel.

### 4.1 Weight Calibration Procedure

1. Fine-balance the wheel in Manual mode.

It is advisable to use a wheel of a size similar to those most commonly balanced (for example, a 14" wheel). Mount the wheel carefully. Press Enter on the input panel and program the wheel dimensions. Set Normal weight mode.

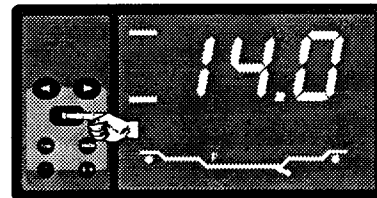

Balance the wheel to '0.00' in Fine Mode.



2. Attach the Calibration weight.

If weights are displayed in ounces, a 3-ounce weight must be used for calibration. If weights are displayed in grams, then a 100-gram weight must be used. With the balancer displaying '0.00' constantly for a balanced wheel, rotate the wheel until all outer weight location indicators are lit. Attach the weight to the outer wheel rim at the TDC (12 o'clock) position. 3. Start the Weight Calibration programme.

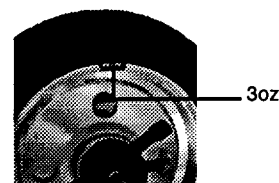

To start the Weight Calibration Programme, press and hold the Left Arrow and then press and hold Fine on the input panel. Keep both buttons pressed for 1 second. The balancer will beep and a flashing 'ccc' will appear on the numeric display. Only the outer green clip-on weight on the rim profile is illuminated.

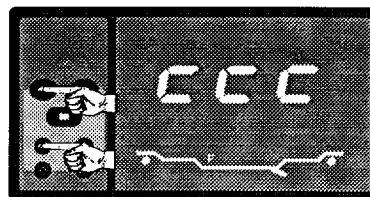

#### 4. Spin the wheel.

Lower the frame to motor-spin the wheel, or hand-spin the wheel. The balancer will beep and perform a measuring cycle. The brake will be automatically applied at the end of the cycle.

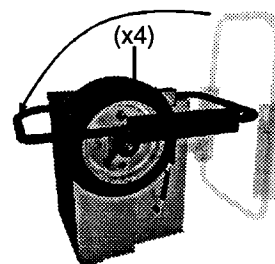

#### 5. Repeat wheel spins.

A minimum of 4 spins are needed for a successful calibration. Another spin is required when the balancer displays a flashing 'ccc' after a measuring cycle.

#### 6. End of Calibration.

When calibration is completed successfully (no more spins required), the display will show the calibration weight value - '3.00' or '100'. This value will be displayed for all wheel positions except when the wheel is rotated to the inner light spot, when '0.00' will be displayed.

After successful calibration, the balancer stores the new calibration values in memory. These new calibration values will be retained even when the power is switched off.

If you wish to quit the Weight Calibration procedure without completion, press Mode on the input panel.



To start the Weight Calibration Programme, press and hold the Left Arrow and then press and hold Fine on the input panel. Keep both buttons pressed for 1 second. The balancer will beep and a flashing 'ccc' will appear on the numeric display. Only the outer green clip-on weight on the rim profile is illuminated.

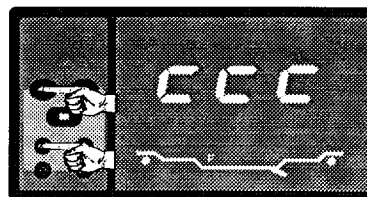

#### 4. Spin the wheel.

Lower the frame to motor-spin the wheel, or hand-spin the wheel. The balancer will beep and perform a measuring cycle. The brake will be automatically applied at the end of the cycle.

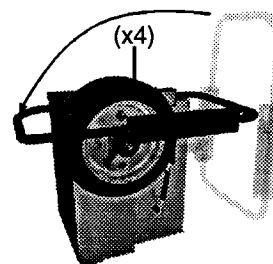

#### 5. Repeat wheel spins.

A minimum of 4 spins are needed for a successful calibration. Another spin is required when the balancer displays a flashing 'ccc' after a measuring cycle.

#### 6. End of Calibration.

When calibration is completed successfully (no more spins required), the display will show the calibration weight value - '3.00' or '100'. This value will be displayed for all wheel positions except when the wheel is rotated to the inner light spot, when '0.00' will be displayed.

After successful calibration, the balancer stores the new calibration values in memory. These new calibration values will be retained even when the power is switched off.

If you wish to quit the Weight Calibration procedure without completion, press Mode on the input panel.



### Frame Calibration Procedure

1. Press the Left Arrow and then press Auto on the input panel. Keep both buttons pressed for 1 second. The balancer will beep and '\_FFF\_' will be displayed.

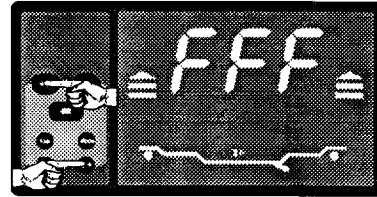

2. Raise the frame to the fully upright position.

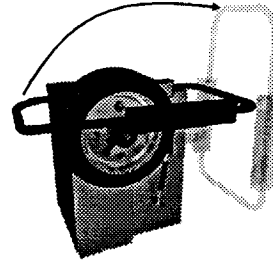

3. Press the Enter on the input panel. The balancer will beep and the display will change to 'FFF'.

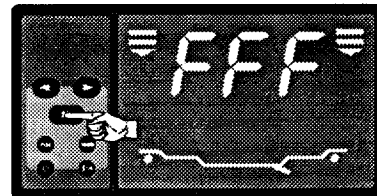

4. Lower the frame to the fully horizontal position.

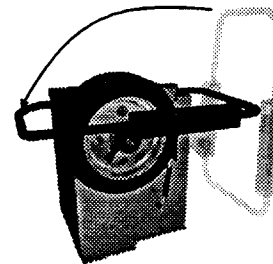

5. Press Enter on the input panel. The balancer will beep and the display will change to '000'. (the motor will NOT start during Frame Calibration).

The calibration of the frame is now complete. The display will be cleared after a few seconds. The balancer may now be used normally.

After successful calibration, the balancer stores the new calibration values in memory. These new calibration values will be retained even when the power is switched off.

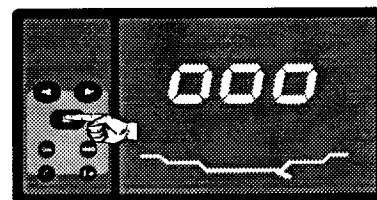



## 4. CALIBRATION

Each balancer is calibrated by computer before shipment from the factory to ensure accuracy of measurements. There should be no requirement to recalibrate in normal service. However, the balancer may need to be calibrated again if :

- The electronics assembly or the sensors have to be replaced.
- The PCB Door assembly has to be replaced.
- The Back Pannel assembly has to be replaced.
- The Measuring Head assembly have to be replaced.
- The measuring frame has been replaced.
- Balancing results appear to be irregular or inconsistent.

The balancer has built-in Calibration programmes which require only a few simple steps and can be performed in about the same time as it takes to balance a single wheel.

### 4.1 Weight Calibration Procedure

1. Fine-balance the wheel in Manual mode.

It is advisable to use a wheel of a size similar to those most commonly balanced (for example, a 14" wheel). Mount the wheel carefully. Press Enter on the input panel and program the wheel dimensions. Set Normal weight mode.

Balance the wheel to '0.00' in Fine Mode.

2. Attach the Calibration weight.

If weights are displayed in ounces, a 3-ounce weight must be used for calibration. If weights are displayed in grams, then a 100-gram weight must be used. With the balancer displaying '0.00' constantly for a balanced wheel, rotate the wheel until all outer weight location indicators are lit. Attach the weight to the outer wheel rim at the TDC (12 o'clock) position. 3. Start the Weight Calibration programme.

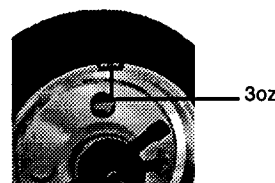
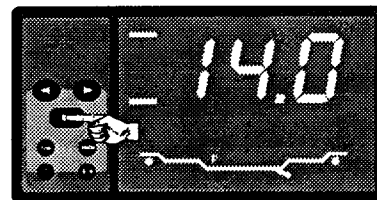

To start the Weight Calibration Programme, press and hold the Left Arrow and then press and hold Fine on the input panel. Keep both buttons pressed for 1 second. The balancer will beep and a flashing 'ccc' will appear on the numeric display. Only the outer green clip-on weight on the rim profile is illuminated.

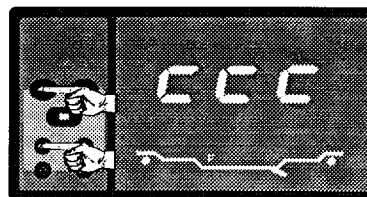

#### 4. Spin the wheel.

Lower the frame to motor-spin the wheel, or hand-spin the wheel. The balancer will beep and perform a measuring cycle. The brake will be automatically applied at the end of the cycle.

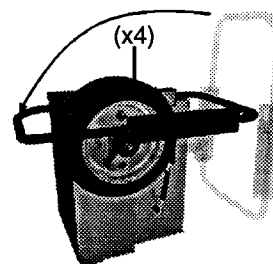

#### 5. Repeat wheel spins.

A minimum of 4 spins are needed for a successful calibration. Another spin is required when the balancer displays a flashing 'ccc' after a measuring cycle.

#### 6. End of Calibration.

When calibration is completed successfully (no more spins required), the display will show the calibration weight value - '3.00' or '100'. This value will be displayed for all wheel positions except when the wheel is rotated to the inner light spot, when '0.00' will be displayed.

After successful calibration, the balancer stores the new calibration values in memory. These new calibration values will be retained even when the power is switched off.

If you wish to quit the Weight Calibration procedure without completion, press Mode on the input panel.



### Frame Calibration Procedure

1. Press the Left Arrow and then press Auto on the input panel. Keep both buttons pressed for 1 second. The balancer will beep and '\_FFF\_' will be displayed.

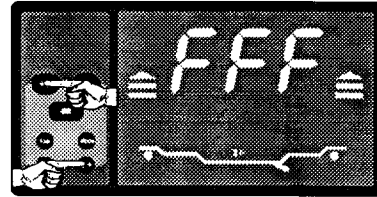

2. Raise the frame to the fully upright position.

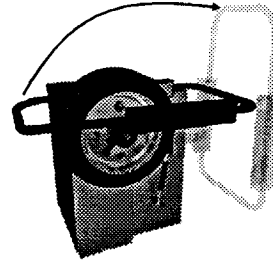

3. Press the Enter on the input panel. The balancer will beep and the display will change to 'FFF'.

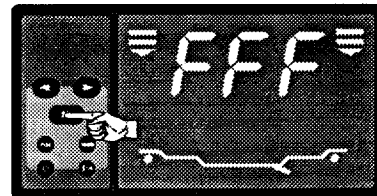

4. Lower the frame to the fully horizontal position.

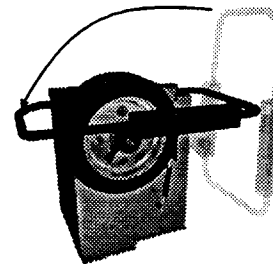

5. Press Enter on the input panel. The balancer will beep and the display will change to '000'. (the motor will NOT start during Frame Calibration).

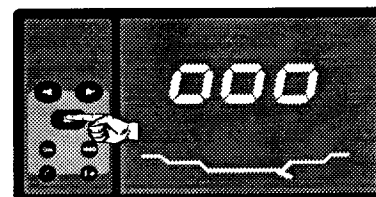

The calibration of the frame is now complete. The display will be cleared after a few seconds. The balancer may now be used normally.

After successful calibration, the balancer stores the new calibration values in memory. These new calibration values will be retained even when the power is switched off.

### Frame Calibration Procedure

1. Press the Left Arrow and then press Auto on the input panel. Keep both buttons pressed for 1 second. The balancer will beep and '\_FFF\_' will be displayed.

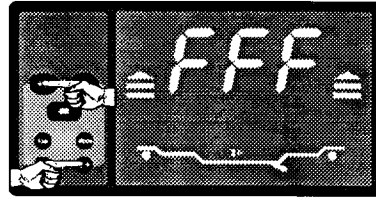

2. Raise the frame to the fully upright position.

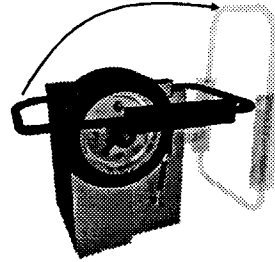

3. Press the Enter on the input panel. The balancer will beep and the display will change to 'FFF'.

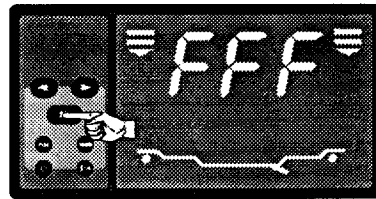

4. Lower the frame to the fully horizontal position.

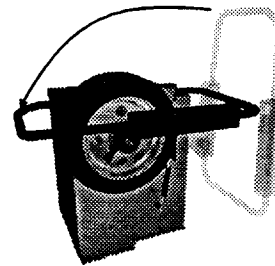

5. Press Enter on the input panel. The balancer will beep and the display will change to '000'. (the motor will NOT start during Frame Calibration).

The calibration of the frame is now complete. The display will be cleared after a few seconds. The balancer may now be used normally.

After successful calibration, the balancer stores the new calibration values in memory. These new calibration values will be retained even when the power is switched off.

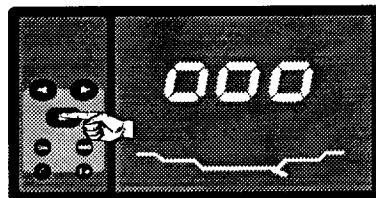

If you wish to quit the Frame Calibration procedure before completion, press Mode on the input panel. The original calibration values will be retained.

### Frame Calibration Errors

If an error occurs during Frame Calibration, the balancer displays error codes on the display. Such errors are described below.

- Frame has not been raised to the fully upright position (when it should have been raised fully).
- Frame has not been moved (when it should have been lowered fully).
- Frame has not been lowered to the fully horizontal position.
- The Frame Encoder which measures frame movement has failed.
- The Frame Encoder which measures frame movement has slipped from its factory-set position.
- The new Calibration Information could not be stored permanently in the balancer.

Each of these error codes will disappear after a few seconds from the display and the balancer will start again at the beginning of the Frame Calibration Procedure.

Repeat the steps of the Frame Calibration Procedure above, or press Mode on the input panel to quit the Frame Calibration Procedure.

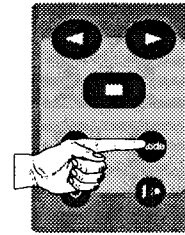

E42

E43

E44 E45 E46

E47

E48

E49

If you wish to quit the Frame Calibration procedure before completion, press Mode on the input panel. The original calibration values will be retained.

### Frame Calibration Errors

If an error occurs during Frame Calibration, the balancer displays error codes on the display. Such errors are described below.

- Frame has not been raised to the fully upright position (when it should have been raised fully).
- Frame has not been moved (when it should have been lowered fully).
- Frame has not been lowered to the fully horizontal position.
- The Frame Encoder which measures frame movement has failed.
- The Frame Encoder which measures frame movement has slipped from its factory-set position.
- The new Calibration Information could not be stored permanently in the balancer.

Each of these error codes will disappear after a few seconds from the display and the balancer will start again at the beginning of the Frame Calibration Procedure.

Repeat the steps of the Frame Calibration Procedure above, or press Mode on the input panel to quit the Frame Calibration Procedure.

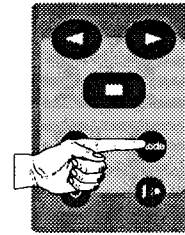

E42

E43

E44 E45 E46

E47

E48

E49

## SERVICE AND MAINTENANCE

The CWB 1858 Wheel Balancer can be maintained with a few simple actions performed at regular intervals.

Wheel mounting accessories and the mounting surfaces of the flange and shaft of the balancer need to be cleaned regularly. Grease and oil will accumulate dirt which can cause incorrect balancing readings, and can also act as a grinding compound resulting in premature wear.

Old wheel weights and other material must be removed from under the balancer. The balancer must rest only on the three machine feet.

Ensure that tires, rims, tools or other parts are not left leaning against the body of the balancer.

Clean the display and input panels with a dry cloth.

If the balancer gets physically damaged or broken, use the Spare Parts List provided with the balancer to identify the parts to be replaced.

Always comply with the safety precautions and instructions described at the beginning of this manual.

### Operational Check

1. Attach the power cord. Switch on the balancer.
2. Press Mode several times. The Weight Mode indicators should light corresponding to each weight mode selected. Return to the Normal weight mode.
3. Press Fine to set Fine Mode. The Fine indicator should light. The Auto indicator should also be displayed.

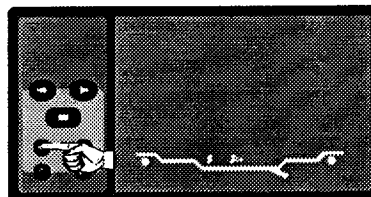
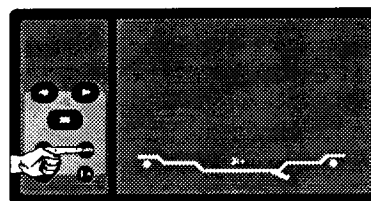
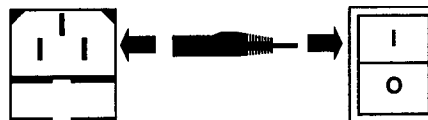

## 4. CALIBRATION

Each balancer is calibrated by computer before shipment from the factory to ensure accuracy of measurements. There should be no requirement to recalibrate in normal service. However, the balancer may need to be calibrated again if :

- The electronics assembly or the sensors have to be replaced.
- The PCB Door assembly has to be replaced.
- The Back Pannel assembly has to be replaced.
- The Measuring Head assembly have to be replaced.
- The measuring frame has been replaced.
- Balancing results appear to be irregular or inconsistent.

The balancer has built-in Calibration programmes which require only a few simple steps and can be performed in about the same time as it takes to balance a single wheel.

### 4.1 Weight Calibration Procedure

1. Fine-balance the wheel in Manual mode.

It is advisable to use a wheel of a size similar to those most commonly balanced (for example, a 14" wheel). Mount the wheel carefully. Press Enter on the input panel and program the wheel dimensions. Set Normal weight mode.

Balance the wheel to '0.00' in Fine Mode.

2. Attach the Calibration weight.

If weights are displayed in ounces, a 3-ounce weight must be used for calibration. If weights are displayed in grams, then a 100-gram weight must be used. With the balancer displaying '0.00' constantly for a balanced wheel, rotate the wheel until all outer weight location indicators are lit. Attach the weight to the outer wheel rim at the TDC (12 o'clock) position.3. Start the Weight Calibration programme.

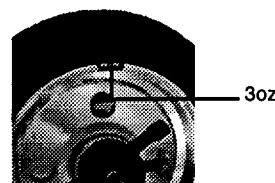
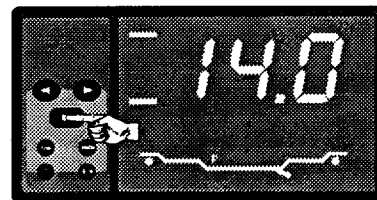



## SERVICE AND MAINTENANCE

The CWB 1858 Wheel Balancer can be maintained with a few simple actions performed at regular intervals.

Wheel mounting accessories and the mounting surfaces of the flange and shaft of the balancer need to be cleaned regularly. Grease and oil will accumulate dirt which can cause incorrect balancing readings, and can also act as a grinding compound resulting in premature wear.

Old wheel weights and other material must be removed from under the balancer. The balancer must rest only on the three machine feet.

Ensure that tires, rims, tools or other parts are not left leaning against the body of the balancer.

Clean the display and input panels with a dry cloth.

If the balancer gets physically damaged or broken, use the Spare Parts List provided with the balancer to identify the parts to be replaced.

Always comply with the safety precautions and instructions described at the beginning of this manual.

### Operational Check

1. Attach the power cord. Switch on the balancer.
2. Press Mode several times. The Weight Mode indicators should light corresponding to each weight mode selected. Return to the Normal weight mode.
3. Press Fine to set Fine Mode. The Fine indicator should light. The Auto indicator should also be displayed.

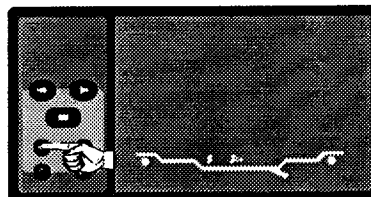
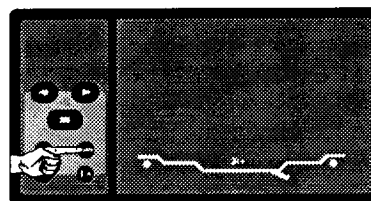
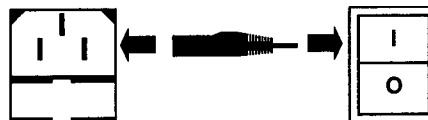

## 4. CALIBRATION

Each balancer is calibrated by computer before shipment from the factory to ensure accuracy of measurements. There should be no requirement to recalibrate in normal service. However, the balancer may need to be calibrated again if :

- The electronics assembly or the sensors have to be replaced.
- The PCB Door assembly has to be replaced.
- The Back Pannel assembly has to be replaced.
- The Measuring Head assembly have to be replaced.
- The measuring frame has been replaced.
- Balancing results appear to be irregular or inconsistent.

The balancer has built-in Calibration programmes which require only a few simple steps and can be performed in about the same time as it takes to balance a single wheel.

### 4.1 Weight Calibration Procedure

#### 1. Fine-balance the wheel in Manual mode.

It is advisable to use a wheel of a size similar to those most commonly balanced (for example, a 14" wheel). Mount the wheel carefully. Press Enter on the input panel and program the wheel dimensions. Set Normal weight mode.

Balance the wheel to '0.00' in Fine Mode.

#### 2. Attach the Calibration weight.

If weights are displayed in ounces, a 3-ounce weight must be used for calibration. If weights are displayed in grams, then a 100-gram weight must be used. With the balancer displaying '0.00' constantly for a balanced wheel, rotate the wheel until all outer weight location indicators are lit. Attach the weight to the outer wheel rim at the TDC (12 o'clock) position.3. Start the Weight Calibration programme.

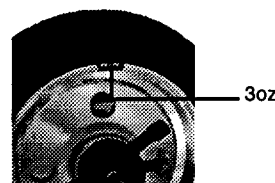
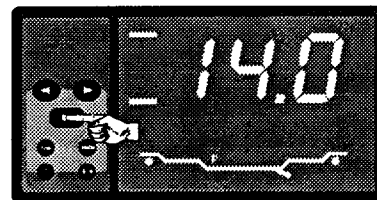

## 4. CALIBRATION

Each balancer is calibrated by computer before shipment from the factory to ensure accuracy of measurements. There should be no requirement to recalibrate in normal service. However, the balancer may need to be calibrated again if :

- The electronics assembly or the sensors have to be replaced.
- The PCB Door assembly has to be replaced.
- The Back Pannel assembly has to be replaced.
- The Measuring Head assembly have to be replaced.
- The measuring frame has been replaced.
- Balancing results appear to be irregular or inconsistent.

The balancer has built-in Calibration programmes which require only a few simple steps and can be performed in about the same time as it takes to balance a single wheel.

### 4.1 Weight Calibration Procedure

1. Fine-balance the wheel in Manual mode.

It is advisable to use a wheel of a size similar to those most commonly balanced (for example, a 14" wheel). Mount the wheel carefully. Press Enter on the input panel and program the wheel dimensions. Set Normal weight mode.

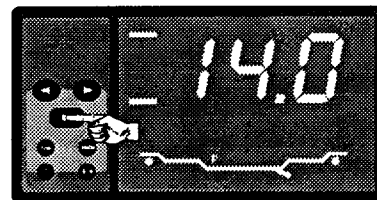

Balance the wheel to '0.00' in Fine Mode.



2. Attach the Calibration weight.

If weights are displayed in ounces, a 3-ounce weight must be used for calibration. If weights are displayed in grams, then a 100-gram weight must be used. With the balancer displaying '0.00' constantly for a balanced wheel, rotate the wheel until all outer weight location indicators are lit. Attach the weight to the outer wheel rim at the TDC (12 o'clock) position. 3. Start the Weight Calibration programme.

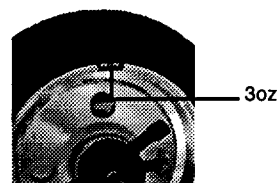

To start the Weight Calibration Programme, press and hold the Left Arrow and then press and hold Fine on the input panel. Keep both buttons pressed for 1 second. The balancer will beep and a flashing 'ccc' will appear on the numeric display. Only the outer green clip-on weight on the rim profile is illuminated.

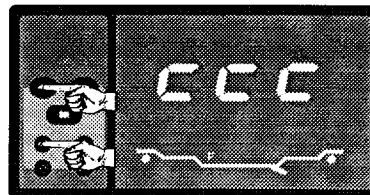

#### 4. Spin the wheel.

Lower the frame to motor-spin the wheel, or hand-spin the wheel. The balancer will beep and perform a measuring cycle. The brake will be automatically applied at the end of the cycle.

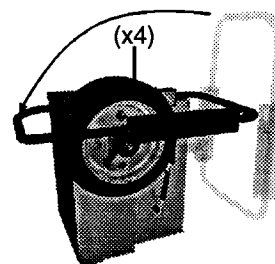

#### 5. Repeat wheel spins.

A minimum of 4 spins are needed for a successful calibration. Another spin is required when the balancer displays a flashing 'ccc' after a measuring cycle.

#### 6. End of Calibration.

When calibration is completed successfully (no more spins required), the display will show the calibration weight value - '3.00' or '100'. This value will be displayed for all wheel positions except when the wheel is rotated to the inner light spot, when '0.00' will be displayed.

After successful calibration, the balancer stores the new calibration values in memory. These new calibration values will be retained even when the power is switched off.

If you wish to quit the Weight Calibration procedure without completion, press Mode on the input panel.



To start the Weight Calibration Programme, press and hold the Left Arrow and then press and hold Fine on the input panel. Keep both buttons pressed for 1 second. The balancer will beep and a flashing 'ccc' will appear on the numeric display. Only the outer green clip-on weight on the rim profile is illuminated.

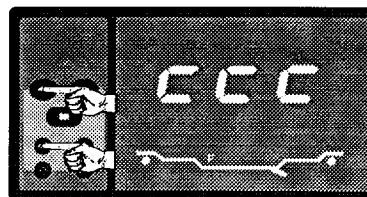

#### 4. Spin the wheel.

Lower the frame to motor-spin the wheel, or hand-spin the wheel. The balancer will beep and perform a measuring cycle. The brake will be automatically applied at the end of the cycle.

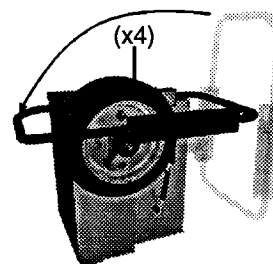

#### 5. Repeat wheel spins.

A minimum of 4 spins are needed for a successful calibration. Another spin is required when the balancer displays a flashing 'ccc' after a measuring cycle.

#### 6. End of Calibration.

When calibration is completed successfully (no more spins required), the display will show the calibration weight value - '3.00' or '100'. This value will be displayed for all wheel positions except when the wheel is rotated to the inner light spot, when '0.00' will be displayed.

After successful calibration, the balancer stores the new calibration values in memory. These new calibration values will be retained even when the power is switched off.

If you wish to quit the Weight Calibration procedure without completion, press Mode on the input panel.



### Frame Calibration Procedure

1. Press the Left Arrow and then press Auto on the input panel. Keep both buttons pressed for 1 second. The balancer will beep and '\_FFF\_' will be displayed.

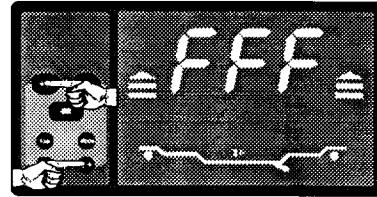

2. Raise the frame to the fully upright position.

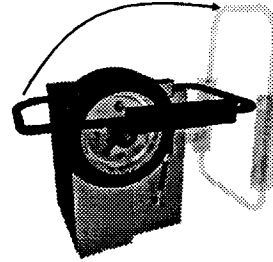

3. Press the Enter on the input panel. The balancer will beep and the display will change to 'FFF'.

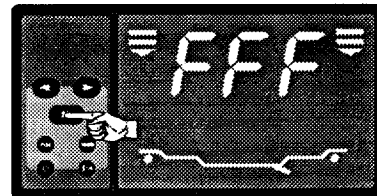

4. Lower the frame to the fully horizontal position.

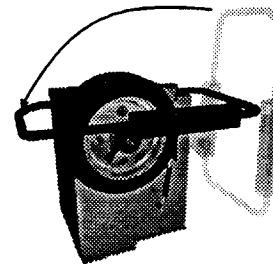

5. Press Enter on the input panel. The balancer will beep and the display will change to '000'. (the motor will NOT start during Frame Calibration).

The calibration of the frame is now complete. The display will be cleared after a few seconds. The balancer may now be used normally.

After successful calibration, the balancer stores the new calibration values in memory. These new calibration values will be retained even when the power is switched off.

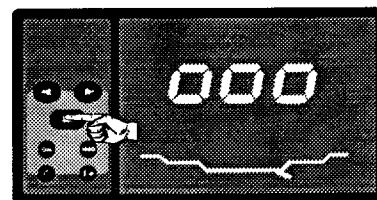

## 4. CALIBRATION

Each balancer is calibrated by computer before shipment from the factory to ensure accuracy of measurements. There should be no requirement to recalibrate in normal service. However, the balancer may need to be calibrated again if :

- The electronics assembly or the sensors have to be replaced.
- The PCB Door assembly has to be replaced.
- The Back Pannel assembly has to be replaced.
- The Measuring Head assembly have to be replaced.
- The measuring frame has been replaced.
- Balancing results appear to be irregular or inconsistent.

The balancer has built-in Calibration programmes which require only a few simple steps and can be performed in about the same time as it takes to balance a single wheel.

### 4.1 Weight Calibration Procedure

#### 1. Fine-balance the wheel in Manual mode.

It is advisable to use a wheel of a size similar to those most commonly balanced (for example, a 14" wheel). Mount the wheel carefully. Press Enter on the input panel and program the wheel dimensions. Set Normal weight mode.

Balance the wheel to '0.00' in Fine Mode.

#### 2. Attach the Calibration weight.

If weights are displayed in ounces, a 3-ounce weight must be used for calibration. If weights are displayed in grams, then a 100-gram weight must be used. With the balancer displaying '0.00' constantly for a balanced wheel, rotate the wheel until all outer weight location indicators are lit. Attach the weight to the outer wheel rim at the TDC (12 o'clock) position.3. Start the Weight Calibration programme.

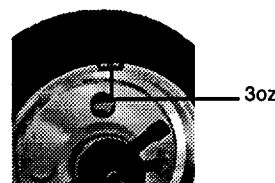
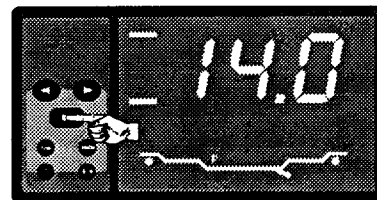

To start the Weight Calibration Programme, press and hold the Left Arrow and then press and hold Fine on the input panel. Keep both buttons pressed for 1 second. The balancer will beep and a flashing 'ccc' will appear on the numeric display. Only the outer green clip-on weight on the rim profile is illuminated.

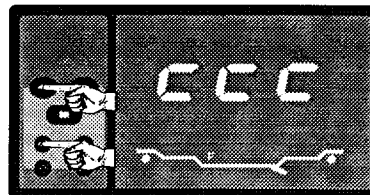

#### 4. Spin the wheel.

Lower the frame to motor-spin the wheel, or hand-spin the wheel. The balancer will beep and perform a measuring cycle. The brake will be automatically applied at the end of the cycle.

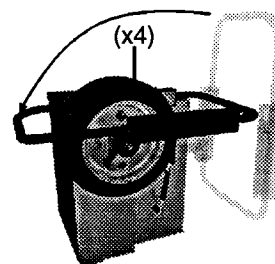

#### 5. Repeat wheel spins.

A minimum of 4 spins are needed for a successful calibration. Another spin is required when the balancer displays a flashing 'ccc' after a measuring cycle.

#### 6. End of Calibration.

When calibration is completed successfully (no more spins required), the display will show the calibration weight value - '3.00' or '100'. This value will be displayed for all wheel positions except when the wheel is rotated to the inner light spot, when '0.00' will be displayed.

After successful calibration, the balancer stores the new calibration values in memory. These new calibration values will be retained even when the power is switched off.

If you wish to quit the Weight Calibration procedure without completion, press Mode on the input panel.





### Frame Calibration Procedure

1. Press the Left Arrow and then press Auto on the input panel. Keep both buttons pressed for 1 second. The balancer will beep and '\_FFF\_' will be displayed.

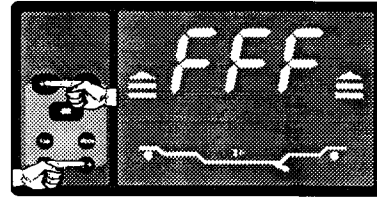

2. Raise the frame to the fully upright position.

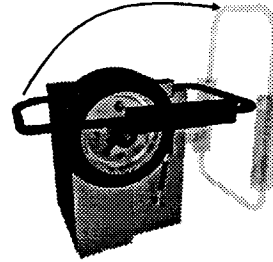

3. Press the Enter on the input panel. The balancer will beep and the display will change to 'FFF'.

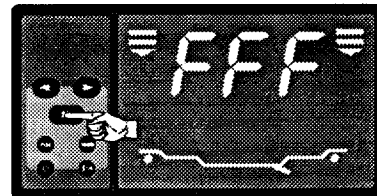

4. Lower the frame to the fully horizontal position.

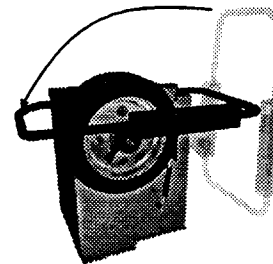

5. Press Enter on the input panel. The balancer will beep and the display will change to '000'. (the motor will NOT start during Frame Calibration).

The calibration of the frame is now complete. The display will be cleared after a few seconds. The balancer may now be used normally.

After successful calibration, the balancer stores the new calibration values in memory. These new calibration values will be retained even when the power is switched off.

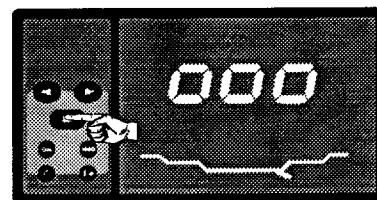

### Frame Calibration Procedure

1. Press the Left Arrow and then press Auto on the input panel. Keep both buttons pressed for 1 second. The balancer will beep and '\_FFF\_' will be displayed.

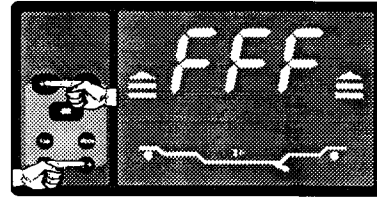

2. Raise the frame to the fully upright position.

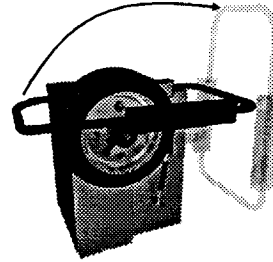

3. Press the Enter on the input panel. The balancer will beep and the display will change to 'FFF'.

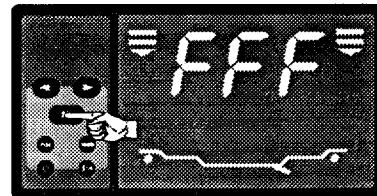

4. Lower the frame to the fully horizontal position.

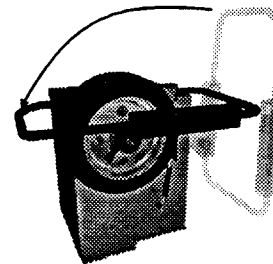

5. Press Enter on the input panel. The balancer will beep and the display will change to '000'. (the motor will NOT start during Frame Calibration).

The calibration of the frame is now complete. The display will be cleared after a few seconds. The balancer may now be used normally.

After successful calibration, the balancer stores the new calibration values in memory. These new calibration values will be retained even when the power is switched off.

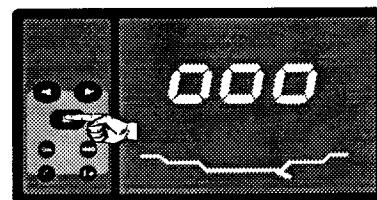

If you wish to quit the Frame Calibration procedure before completion, press Mode on the input panel. The original calibration values will be retained.

### Frame Calibration Errors

If an error occurs during Frame Calibration, the balancer displays error codes on the display. Such errors are described below.

- Frame has not been raised to the fully upright position (when it should have been raised fully).
- Frame has not been moved (when it should have been lowered fully).
- Frame has not been lowered to the fully horizontal position.
- The Frame Encoder which measures frame movement has failed.
- The Frame Encoder which measures frame movement has slipped from its factory-set position.
- The new Calibration Information could not be stored permanently in the balancer.

Each of these error codes will disappear after a few seconds from the display and the balancer will start again at the beginning of the Frame Calibration Procedure.

Repeat the steps of the Frame Calibration Procedure above, or press Mode on the input panel to quit the Frame Calibration Procedure.

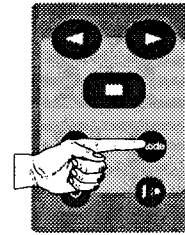

E42

E43

E44 E45 E46

E47

E48

E49

If you wish to quit the Frame Calibration procedure before completion, press Mode on the input panel. The original calibration values will be retained.

### Frame Calibration Errors

If an error occurs during Frame Calibration, the balancer displays error codes on the display. Such errors are described below.

- Frame has not been raised to the fully upright position (when it should have been raised fully).
- Frame has not been moved (when it should have been lowered fully).
- Frame has not been lowered to the fully horizontal position.
- The Frame Encoder which measures frame movement has failed.
- The Frame Encoder which measures frame movement has slipped from its factory-set position.
- The new Calibration Information could not be stored permanently in the balancer.

Each of these error codes will disappear after a few seconds from the display and the balancer will start again at the beginning of the Frame Calibration Procedure.

Repeat the steps of the Frame Calibration Procedure above, or press Mode on the input panel to quit the Frame Calibration Procedure.

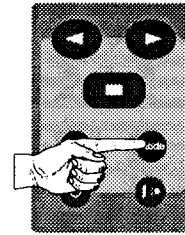

E42

E43

E44 E45 E46

E47

E48

E49

## SERVICE AND MAINTENANCE

The CWB 1858 Wheel Balancer can be maintained with a few simple actions performed at regular intervals.

Wheel mounting accessories and the mounting surfaces of the flange and shaft of the balancer need to be cleaned regularly. Grease and oil will accumulate dirt which can cause incorrect balancing readings, and can also act as a grinding compound resulting in premature wear.

Old wheel weights and other material must be removed from under the balancer. The balancer must rest only on the three machine feet.

Ensure that tires, rims, tools or other parts are not left leaning against the body of the balancer.

Clean the display and input panels with a dry cloth.

If the balancer gets physically damaged or broken, use the Spare Parts List provided with the balancer to identify the parts to be replaced.

Always comply with the safety precautions and instructions described at the beginning of this manual.

### Operational Check

1. Attach the power cord. Switch on the balancer.
2. Press Mode several times. The Weight Mode indicators should light corresponding to each weight mode selected. Return to the Normal weight mode.
3. Press Fine to set Fine Mode. The Fine indicator should light. The Auto indicator should also be displayed.

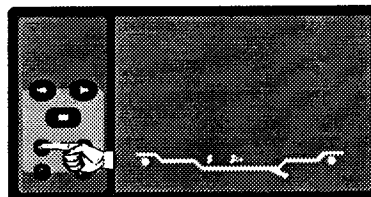
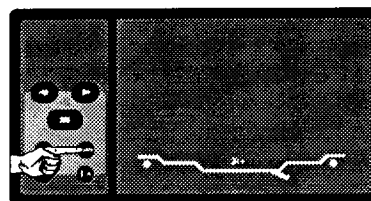
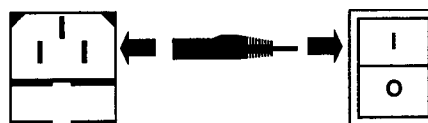

8. Remove the 3-ounce (100-gram) weight and verify that the wheel is balanced in Fine Mode.

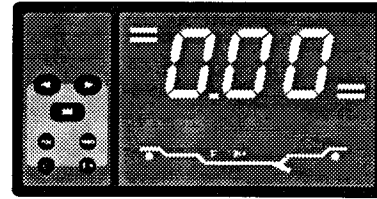

9. Rotate the wheel 180° in relation to the mounting flange and re-spin. The sum of the inner and outer readings should be a maximum of 0.50 ounces (15 grams) for a 14" or smaller wheel. If the sum is higher, make sure the wheel is properly centered when tightening the hub nut. Clean the mounting surface, spindle, cones and wheel, and then repeat the check. If the new sum is also too high, repeat the check with a new wheel.

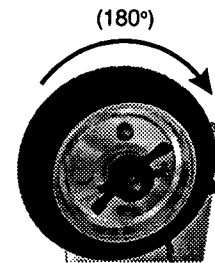

If the balancer fails any of the above steps, contact your service representative for assistance in correcting the problem.

8. Remove the 3-ounce (100-gram) weight and verify that the wheel is balanced in Fine Mode.

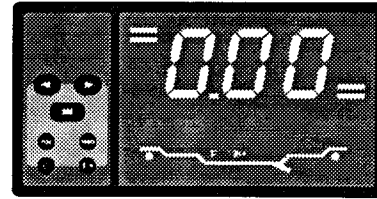

9. Rotate the wheel 180° in relation to the mounting flange and re-spin. The sum of the inner and outer readings should be a maximum of 0.50 ounces (15 grams) for a 14" or smaller wheel. If the sum is higher, make sure the wheel is properly centered when tightening the hub nut. Clean the mounting surface, spindle, cones and wheel, and then repeat the check. If the new sum is also too high, repeat the check with a new wheel.

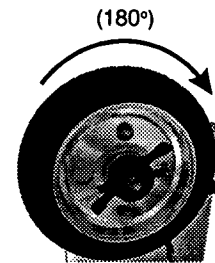

If the balancer fails any of the above steps, contact your service representative for assistance in correcting the problem.

8. Remove the 3-ounce (100-gram) weight and verify that the wheel is balanced in Fine Mode.

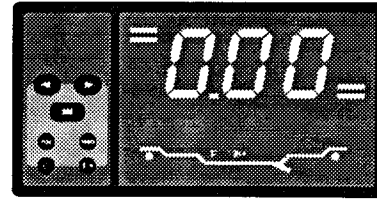

9. Rotate the wheel 180° in relation to the mounting flange and re-spin. The sum of the inner and outer readings should be a maximum of 0.50 ounces (15 grams) for a 14" or smaller wheel. If the sum is higher, make sure the wheel is properly centered when tightening the hub nut. Clean the mounting surface, spindle, cones and wheel, and then repeat the check. If the new sum is also too high, repeat the check with a new wheel.

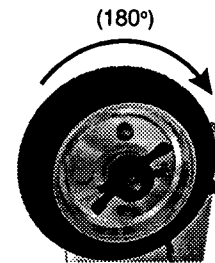

If the balancer fails any of the above steps, contact your service representative for assistance in correcting the problem.



## Troubleshooting Guide

The following tips will help to identify and correct problems which may be encountered when using the wheel balancer.

### A. No indicators on the display panel are lit.

There may be no power supplied to the balancer. A fuse may be blown or a cable may be loose.

Ensure the power cord is inserted properly in the mains inlet at the rear of the balancer unit.

Remove the power cord. Check the fuse in the plug or in the wall outlet. Replace if necessary.

Replace the 10A fuse contained in the small tray of the mains inlet. The inner fuse is in-line; the outer fuse is a spare.

Unplug the power cord. Remove the weight tray and check all cable connections.

### B. Display appears to freeze or lock up.

The power to the balancer may have been interrupted, or the balancer may have been left with the Optimatch programme active.

Turn off the power, wait a few seconds, and turn on the power again.

If the Optimatch programme is active, pressing Fine on the input panel will exit to normal operation.

### C. Balancing results are inconsistent.

The balancer may not be resting on a solid and level surface, the mounting accessories or stub shaft may be worn or damaged, or the electronics assembly or sensors may have been replaced.

Ensure that the balancer is fixed in position.

Inspect the mounting accessories and stub shaft; replace if necessary.

Perform the Weight Calibration procedure.

Move the balancer to a new location and try again (note that the balancer is heavy - do not move the balancer without assistance).

**D. E11 or E21 is displayed during operation.**

The motor may be spinning the shaft up to speed too fast. Alternatively, the wheel may be slowing or stopping during the cycle. This may be due to a) no wheel or a light wheel rim being mounted; b) the wheel slipping on the shaft when the motor accelerates the shaft.

Ensure that the wheel is mounted properly and that the Hub Nut is securely tightening the wheel against the flange; the wheel must not slip on the shaft.

Check that wheel movement is not being impeded.

When only a wheel rim is mounted, the rim may be too light to maintain speed; try spinning the rim a little faster, using a hand-spin.

If the wheel is very heavy and the motor cannot accelerate it to measuring speed, leave the frame raised and try spinning the wheel by hand.

**E. E12 is displayed during operation.**

The frame has been raised before the balancing cycle is completed.

The frame is lowered to start the motor. The balancer will beep once when the wheel reaches measuring speed. Always wait until the end of the balancing cycle (the balancer beeps for the second time and the brake is engaged automatically) before raising the frame again.

**F. E14 is displayed during operation.**

The balancer is in Automatic mode and the frame hasn't been lowered to scan the wheel. The most probable cause is hand-spinning a wheel in this mode.

Repeat the balancing procedure, ensuring a complete scan of the wheel with the frame.



**G. E23 is displayed during operation.**

In hand-spin mode, the wheel has been spun in the wrong direction (anti-clockwise when facing the outer rim).

Respin the wheel, spinning it in the correct direction (clockwise when facing the outer rim).

**H. E24 is displayed during operation.**

The motor is on and there is no movement for more than 2 seconds. This may be caused by grease gathering on the drive wheel, the brake sticking in the engaged position, or the shaft being impeded.

Switch off the balancer and unplug the power cord from the wall outlet. Remove the weight tray. Check for grease on the surface of the drive wheel. If necessary clean surfaces with solvent.

With the power off and the weight tray removed, check that the brake mechanism is not sticking.

Press Auto to change to manual mode and hand-spin the wheel.

**I. E25 is displayed during operation.**

The motor is unable to spin the wheel up to measuring speed within approximately 20 seconds, because the wheel is too heavy or because the mains supply is being interrupted.

Ensure that the wheel is mounted properly and that the Hub Nut is securely tightening the wheel against the flange; the wheel must not slip on the shaft.

Check that wheel movement is not being impeded. When only a wheel rim is mounted, the rim may be too light to maintain speed; try spinning the rim a little faster, using a hand-spin.

If the wheel is very heavy and the motor cannot accelerate it to measuring speed, leave the frame raised and try spinning the wheel by hand.



## 4. CALIBRATION

Each balancer is calibrated by computer before shipment from the factory to ensure accuracy of measurements. There should be no requirement to recalibrate in normal service. However, the balancer may need to be calibrated again if :

- The electronics assembly or the sensors have to be replaced.
- The PCB Door assembly has to be replaced.
- The Back Pannel assembly has to be replaced.
- The Measuring Head assembly have to be replaced.
- The measuring frame has been replaced.
- Balancing results appear to be irregular or inconsistent.

The balancer has built-in Calibration programmes which require only a few simple steps and can be performed in about the same time as it takes to balance a single wheel.

### 4.1 Weight Calibration Procedure

1. Fine-balance the wheel in Manual mode.

It is advisable to use a wheel of a size similar to those most commonly balanced (for example, a 14" wheel). Mount the wheel carefully. Press Enter on the input panel and program the wheel dimensions. Set Normal weight mode.

Balance the wheel to '0.00' in Fine Mode.

2. Attach the Calibration weight.

If weights are displayed in ounces, a 3-ounce weight must be used for calibration. If weights are displayed in grams, then a 100-gram weight must be used. With the balancer displaying '0.00' constantly for a balanced wheel, rotate the wheel until all outer weight location indicators are lit. Attach the weight to the outer wheel rim at the TDC (12 o'clock) position.3. Start the Weight Calibration programme.

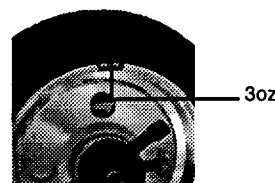
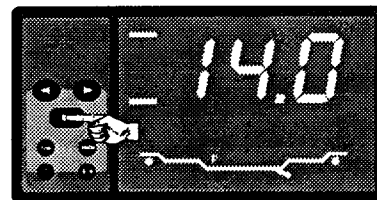

To start the Weight Calibration Programme, press and hold the Left Arrow and then press and hold Fine on the input panel. Keep both buttons pressed for 1 second. The balancer will beep and a flashing 'ccc' will appear on the numeric display. Only the outer green clip-on weight on the rim profile is illuminated.

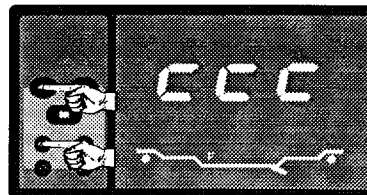

#### 4. Spin the wheel.

Lower the frame to motor-spin the wheel, or hand-spin the wheel. The balancer will beep and perform a measuring cycle. The brake will be automatically applied at the end of the cycle.

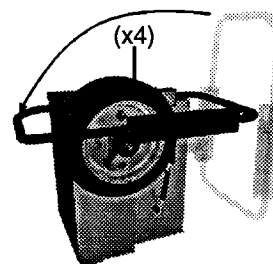

#### 5. Repeat wheel spins.

A minimum of 4 spins are needed for a successful calibration. Another spin is required when the balancer displays a flashing 'ccc' after a measuring cycle.

#### 6. End of Calibration.

When calibration is completed successfully (no more spins required), the display will show the calibration weight value - '3.00' or '100'. This value will be displayed for all wheel positions except when the wheel is rotated to the inner light spot, when '0.00' will be displayed.

After successful calibration, the balancer stores the new calibration values in memory. These new calibration values will be retained even when the power is switched off.

If you wish to quit the Weight Calibration procedure without completion, press Mode on the input panel.



If you wish to quit the Frame Calibration procedure before completion, press Mode on the input panel. The original calibration values will be retained.

### Frame Calibration Errors

If an error occurs during Frame Calibration, the balancer displays error codes on the display. Such errors are described below.

- Frame has not been raised to the fully upright position (when it should have been raised fully).
- Frame has not been moved (when it should have been lowered fully).
- Frame has not been lowered to the fully horizontal position.
- The Frame Encoder which measures frame movement has failed.
- The Frame Encoder which measures frame movement has slipped from its factory-set position.
- The new Calibration Information could not be stored permanently in the balancer.

Each of these error codes will disappear after a few seconds from the display and the balancer will start again at the beginning of the Frame Calibration Procedure.

Repeat the steps of the Frame Calibration Procedure above, or press Mode on the input panel to quit the Frame Calibration Procedure.

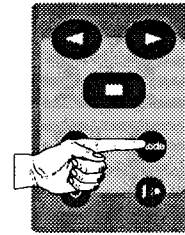

E42

E43

E44 E45 E46

E47

E48

E49

If you wish to quit the Frame Calibration procedure before completion, press Mode on the input panel. The original calibration values will be retained.

### Frame Calibration Errors

If an error occurs during Frame Calibration, the balancer displays error codes on the display. Such errors are described below.

- Frame has not been raised to the fully upright position (when it should have been raised fully).
- Frame has not been moved (when it should have been lowered fully).
- Frame has not been lowered to the fully horizontal position.
- The Frame Encoder which measures frame movement has failed.
- The Frame Encoder which measures frame movement has slipped from its factory-set position.
- The new Calibration Information could not be stored permanently in the balancer.

Each of these error codes will disappear after a few seconds from the display and the balancer will start again at the beginning of the Frame Calibration Procedure.

Repeat the steps of the Frame Calibration Procedure above, or press Mode on the input panel to quit the Frame Calibration Procedure.

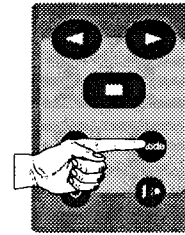

E42

E43

E44 E45 E46

E47

E48

E49

## SERVICE AND MAINTENANCE

The CWB 1858 Wheel Balancer can be maintained with a few simple actions performed at regular intervals.

Wheel mounting accessories and the mounting surfaces of the flange and shaft of the balancer need to be cleaned regularly. Grease and oil will accumulate dirt which can cause incorrect balancing readings, and can also act as a grinding compound resulting in premature wear.

Old wheel weights and other material must be removed from under the balancer. The balancer must rest only on the three machine feet.

Ensure that tires, rims, tools or other parts are not left leaning against the body of the balancer.

Clean the display and input panels with a dry cloth.

If the balancer gets physically damaged or broken, use the Spare Parts List provided with the balancer to identify the parts to be replaced.

Always comply with the safety precautions and instructions described at the beginning of this manual.

### Operational Check

1. Attach the power cord. Switch on the balancer.
2. Press Mode several times. The Weight Mode indicators should light corresponding to each weight mode selected. Return to the Normal weight mode.
3. Press Fine to set Fine Mode. The Fine indicator should light. The Auto indicator should also be displayed.

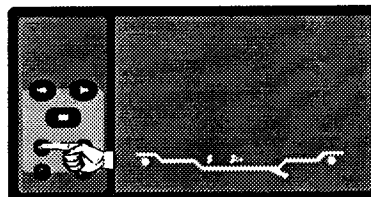
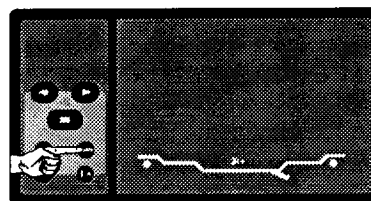
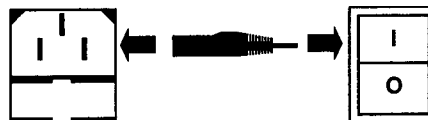



8. Remove the 3-ounce (100-gram) weight and verify that the wheel is balanced in Fine Mode.

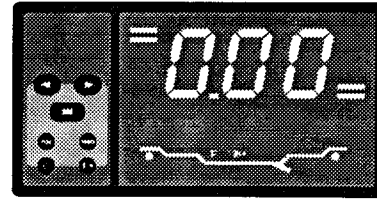

9. Rotate the wheel 180° in relation to the mounting flange and re-spin. The sum of the inner and outer readings should be a maximum of 0.50 ounces (15 grams) for a 14" or smaller wheel. If the sum is higher, make sure the wheel is properly centered when tightening the hub nut. Clean the mounting surface, spindle, cones and wheel, and then repeat the check. If the new sum is also too high, repeat the check with a new wheel.

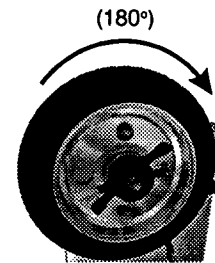

If the balancer fails any of the above steps, contact your service representative for assistance in correcting the problem.

8. Remove the 3-ounce (100-gram) weight and verify that the wheel is balanced in Fine Mode.

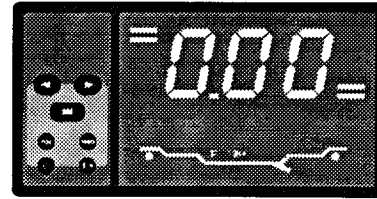

9. Rotate the wheel 180° in relation to the mounting flange and re-spin. The sum of the inner and outer readings should be a maximum of 0.50 ounces (15 grams) for a 14" or smaller wheel. If the sum is higher, make sure the wheel is properly centered when tightening the hub nut. Clean the mounting surface, spindle, cones and wheel, and then repeat the check. If the new sum is also too high, repeat the check with a new wheel.

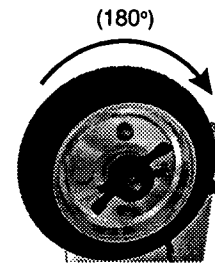

If the balancer fails any of the above steps, contact your service representative for assistance in correcting the problem.

## Troubleshooting Guide

The following tips will help to identify and correct problems which may be encountered when using the wheel balancer.

### A. No indicators on the display panel are lit.

There may be no power supplied to the balancer. A fuse may be blown or a cable may be loose.

Ensure the power cord is inserted properly in the mains inlet at the rear of the balancer unit.

Remove the power cord. Check the fuse in the plug or in the wall outlet. Replace if necessary.

Replace the 10A fuse contained in the small tray of the mains inlet. The inner fuse is in-line; the outer fuse is a spare.

Unplug the power cord. Remove the weight tray and check all cable connections.

### B. Display appears to freeze or lock up.

The power to the balancer may have been interrupted, or the balancer may have been left with the Optimatch programme active.

Turn off the power, wait a few seconds, and turn on the power again.

If the Optimatch programme is active, pressing Fine on the input panel will exit to normal operation.

### C. Balancing results are inconsistent.

The balancer may not be resting on a solid and level surface, the mounting accessories or stub shaft may be worn or damaged, or the electronics assembly or sensors may have been replaced.

Ensure that the balancer is fixed in position.

Inspect the mounting accessories and stub shaft; replace if necessary.

Perform the Weight Calibration procedure.

Move the balancer to a new location and try again (note that the balancer is heavy - do not move the balancer without assistance).

**D. E11 or E21 is displayed during operation.**

The motor may be spinning the shaft up to speed too fast. Alternatively, the wheel may be slowing or stopping during the cycle. This may be due to a) no wheel or a light wheel rim being mounted; b) the wheel slipping on the shaft when the motor accelerates the shaft.

Ensure that the wheel is mounted properly and that the Hub Nut is securely tightening the wheel against the flange; the wheel must not slip on the shaft.

Check that wheel movement is not being impeded.

When only a wheel rim is mounted, the rim may be too light to maintain speed; try spinning the rim a little faster, using a hand-spin.

If the wheel is very heavy and the motor cannot accelerate it to measuring speed, leave the frame raised and try spinning the wheel by hand.

**E. E12 is displayed during operation.**

The frame has been raised before the balancing cycle is completed.

The frame is lowered to start the motor. The balancer will beep once when the wheel reaches measuring speed. Always wait until the end of the balancing cycle (the balancer beeps for the second time and the brake is engaged automatically) before raising the frame again.

**F. E14 is displayed during operation.**

The balancer is in Automatic mode and the frame hasn't been lowered to scan the wheel. The most probable cause is hand-spinning a wheel in this mode.

Repeat the balancing procedure, ensuring a complete scan of the wheel with the frame.



**G. E23 is displayed during operation.**

In hand-spin mode, the wheel has been spun in the wrong direction (anti-clockwise when facing the outer rim).

Respin the wheel, spinning it in the correct direction (clockwise when facing the outer rim).

**H. E24 is displayed during operation.**

The motor is on and there is no movement for more than 2 seconds. This may be caused by grease gathering on the drive wheel, the brake sticking in the engaged position, or the shaft being impeded.

Switch off the balancer and unplug the power cord from the wall outlet. Remove the weight tray. Check for grease on the surface of the drive wheel. If necessary clean surfaces with solvent.

With the power off and the weight tray removed, check that the brake mechanism is not sticking.

Press Auto to change to manual mode and hand-spin the wheel.

**I. E25 is displayed during operation.**

The motor is unable to spin the wheel up to measuring speed within approximately 20 seconds, because the wheel is too heavy or because the mains supply is being interrupted.

Ensure that the wheel is mounted properly and that the Hub Nut is securely tightening the wheel against the flange; the wheel must not slip on the shaft.

Check that wheel movement is not being impeded. When only a wheel rim is mounted, the rim may be too light to maintain speed; try spinning the rim a little faster, using a hand-spin.

If the wheel is very heavy and the motor cannot accelerate it to measuring speed, leave the frame raised and try spinning the wheel by hand.



## 4. CALIBRATION

Each balancer is calibrated by computer before shipment from the factory to ensure accuracy of measurements. There should be no requirement to recalibrate in normal service. However, the balancer may need to be calibrated again if :

- The electronics assembly or the sensors have to be replaced.
- The PCB Door assembly has to be replaced.
- The Back Pannel assembly has to be replaced.
- The Measuring Head assembly have to be replaced.
- The measuring frame has been replaced.
- Balancing results appear to be irregular or inconsistent.

The balancer has built-in Calibration programmes which require only a few simple steps and can be performed in about the same time as it takes to balance a single wheel.

### 4.1 Weight Calibration Procedure

1. Fine-balance the wheel in Manual mode.

It is advisable to use a wheel of a size similar to those most commonly balanced (for example, a 14" wheel). Mount the wheel carefully. Press Enter on the input panel and program the wheel dimensions. Set Normal weight mode.

Balance the wheel to '0.00' in Fine Mode.

2. Attach the Calibration weight.

If weights are displayed in ounces, a 3-ounce weight must be used for calibration. If weights are displayed in grams, then a 100-gram weight must be used. With the balancer displaying '0.00' constantly for a balanced wheel, rotate the wheel until all outer weight location indicators are lit. Attach the weight to the outer wheel rim at the TDC (12 o'clock) position.3. Start the Weight Calibration programme.

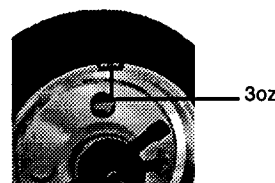
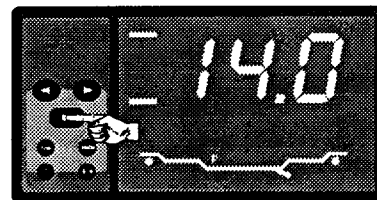

To start the Weight Calibration Programme, press and hold the Left Arrow and then press and hold Fine on the input panel. Keep both buttons pressed for 1 second. The balancer will beep and a flashing 'ccc' will appear on the numeric display. Only the outer green clip-on weight on the rim profile is illuminated.

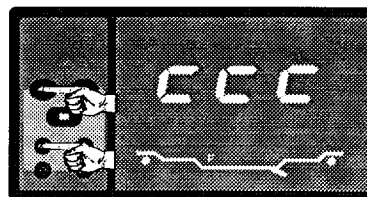

#### 4. Spin the wheel.

Lower the frame to motor-spin the wheel, or hand-spin the wheel. The balancer will beep and perform a measuring cycle. The brake will be automatically applied at the end of the cycle.

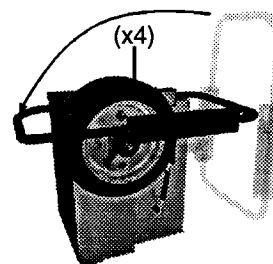

#### 5. Repeat wheel spins.

A minimum of 4 spins are needed for a successful calibration. Another spin is required when the balancer displays a flashing 'ccc' after a measuring cycle.

#### 6. End of Calibration.

When calibration is completed successfully (no more spins required), the display will show the calibration weight value - '3.00' or '100'. This value will be displayed for all wheel positions except when the wheel is rotated to the inner light spot, when '0.00' will be displayed.

After successful calibration, the balancer stores the new calibration values in memory. These new calibration values will be retained even when the power is switched off.

If you wish to quit the Weight Calibration procedure without completion, press Mode on the input panel.



### Frame Calibration Procedure

1. Press the Left Arrow and then press Auto on the input panel. Keep both buttons pressed for 1 second. The balancer will beep and '\_FFF\_' will be displayed.

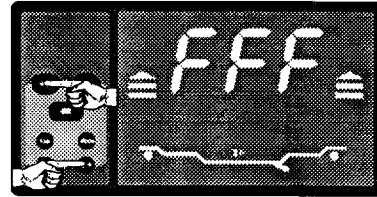

2. Raise the frame to the fully upright position.

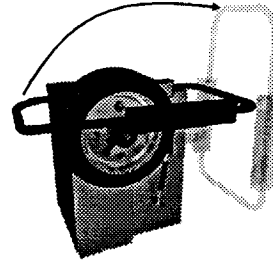

3. Press the Enter on the input panel. The balancer will beep and the display will change to 'FFF'.

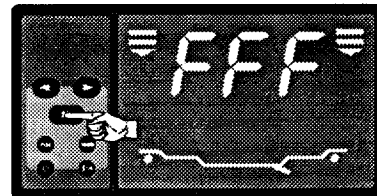

4. Lower the frame to the fully horizontal position.

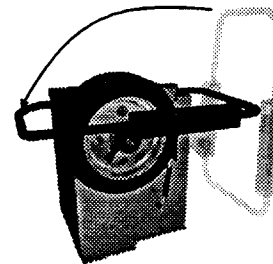

5. Press Enter on the input panel. The balancer will beep and the display will change to '000'. (the motor will NOT start during Frame Calibration).

The calibration of the frame is now complete. The display will be cleared after a few seconds. The balancer may now be used normally.

After successful calibration, the balancer stores the new calibration values in memory. These new calibration values will be retained even when the power is switched off.

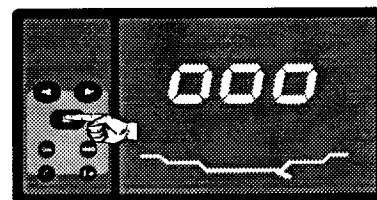



## 4. CALIBRATION

Each balancer is calibrated by computer before shipment from the factory to ensure accuracy of measurements. There should be no requirement to recalibrate in normal service. However, the balancer may need to be calibrated again if :

- The electronics assembly or the sensors have to be replaced.
- The PCB Door assembly has to be replaced.
- The Back Pannel assembly has to be replaced.
- The Measuring Head assembly have to be replaced.
- The measuring frame has been replaced.
- Balancing results appear to be irregular or inconsistent.

The balancer has built-in Calibration programmes which require only a few simple steps and can be performed in about the same time as it takes to balance a single wheel.

### 4.1 Weight Calibration Procedure

1. Fine-balance the wheel in Manual mode.

It is advisable to use a wheel of a size similar to those most commonly balanced (for example, a 14" wheel). Mount the wheel carefully. Press Enter on the input panel and program the wheel dimensions. Set Normal weight mode.

Balance the wheel to '0.00' in Fine Mode.

2. Attach the Calibration weight.

If weights are displayed in ounces, a 3-ounce weight must be used for calibration. If weights are displayed in grams, then a 100-gram weight must be used. With the balancer displaying '0.00' constantly for a balanced wheel, rotate the wheel until all outer weight location indicators are lit. Attach the weight to the outer wheel rim at the TDC (12 o'clock) position.3. Start the Weight Calibration programme.

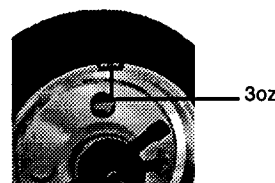
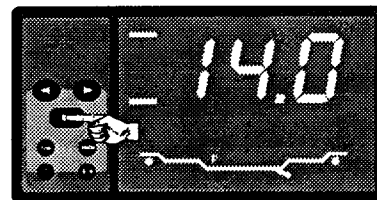

To start the Weight Calibration Programme, press and hold the Left Arrow and then press and hold Fine on the input panel. Keep both buttons pressed for 1 second. The balancer will beep and a flashing 'ccc' will appear on the numeric display. Only the outer green clip-on weight on the rim profile is illuminated.

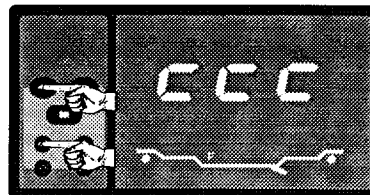

#### 4. Spin the wheel.

Lower the frame to motor-spin the wheel, or hand-spin the wheel. The balancer will beep and perform a measuring cycle. The brake will be automatically applied at the end of the cycle.

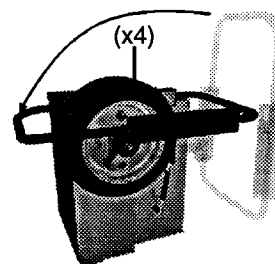

#### 5. Repeat wheel spins.

A minimum of 4 spins are needed for a successful calibration. Another spin is required when the balancer displays a flashing 'ccc' after a measuring cycle.

#### 6. End of Calibration.

When calibration is completed successfully (no more spins required), the display will show the calibration weight value - '3.00' or '100'. This value will be displayed for all wheel positions except when the wheel is rotated to the inner light spot, when '0.00' will be displayed.

After successful calibration, the balancer stores the new calibration values in memory. These new calibration values will be retained even when the power is switched off.

If you wish to quit the Weight Calibration procedure without completion, press Mode on the input panel.



### Frame Calibration Procedure

1. Press the Left Arrow and then press Auto on the input panel. Keep both buttons pressed for 1 second. The balancer will beep and '\_FFF\_' will be displayed.

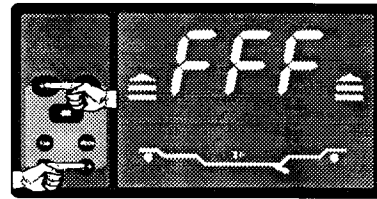

2. Raise the frame to the fully upright position.

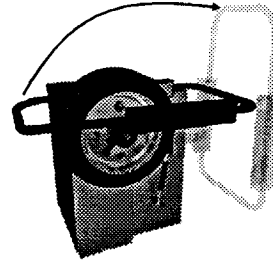

3. Press the Enter on the input panel. The balancer will beep and the display will change to 'FFF'.

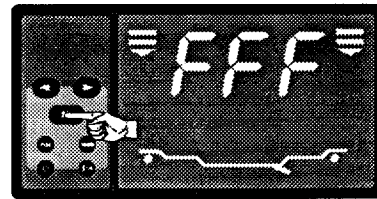

4. Lower the frame to the fully horizontal position.

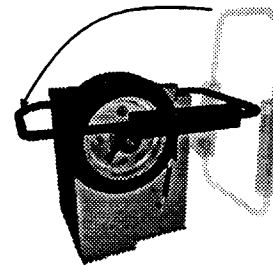

5. Press Enter on the input panel. The balancer will beep and the display will change to '000'. (the motor will NOT start during Frame Calibration).

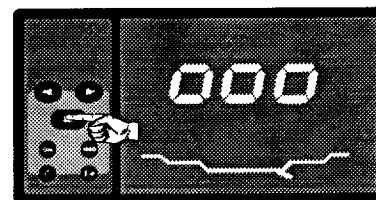

The calibration of the frame is now complete. The display will be cleared after a few seconds. The balancer may now be used normally.

After successful calibration, the balancer stores the new calibration values in memory. These new calibration values will be retained even when the power is switched off.

If you wish to quit the Frame Calibration procedure before completion, press Mode on the input panel. The original calibration values will be retained.

### Frame Calibration Errors

If an error occurs during Frame Calibration, the balancer displays error codes on the display. Such errors are described below.

- Frame has not been raised to the fully upright position (when it should have been raised fully).
- Frame has not been moved (when it should have been lowered fully).
- Frame has not been lowered to the fully horizontal position.
- The Frame Encoder which measures frame movement has failed.
- The Frame Encoder which measures frame movement has slipped from its factory-set position.
- The new Calibration Information could not be stored permanently in the balancer.

Each of these error codes will disappear after a few seconds from the display and the balancer will start again at the beginning of the Frame Calibration Procedure.

Repeat the steps of the Frame Calibration Procedure above, or press Mode on the input panel to quit the Frame Calibration Procedure.

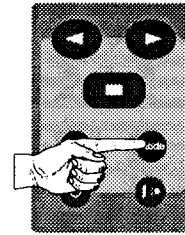

E42

E43

E44

E45

E46

E47

E48

E49

If you wish to quit the Frame Calibration procedure before completion, press Mode on the input panel. The original calibration values will be retained.

### Frame Calibration Errors

If an error occurs during Frame Calibration, the balancer displays error codes on the display. Such errors are described below.

- Frame has not been raised to the fully upright position (when it should have been raised fully).
- Frame has not been moved (when it should have been lowered fully).
- Frame has not been lowered to the fully horizontal position.
- The Frame Encoder which measures frame movement has failed.
- The Frame Encoder which measures frame movement has slipped from its factory-set position.
- The new Calibration Information could not be stored permanently in the balancer.

Each of these error codes will disappear after a few seconds from the display and the balancer will start again at the beginning of the Frame Calibration Procedure.

Repeat the steps of the Frame Calibration Procedure above, or press Mode on the input panel to quit the Frame Calibration Procedure.

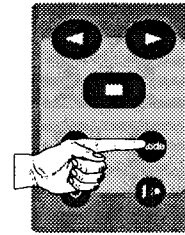

E42

E43

E44 E45 E46

E47

E48

E49

## SERVICE AND MAINTENANCE

The CWB 1858 Wheel Balancer can be maintained with a few simple actions performed at regular intervals.

Wheel mounting accessories and the mounting surfaces of the flange and shaft of the balancer need to be cleaned regularly. Grease and oil will accumulate dirt which can cause incorrect balancing readings, and can also act as a grinding compound resulting in premature wear.

Old wheel weights and other material must be removed from under the balancer. The balancer must rest only on the three machine feet.

Ensure that tires, rims, tools or other parts are not left leaning against the body of the balancer.

Clean the display and input panels with a dry cloth.

If the balancer gets physically damaged or broken, use the Spare Parts List provided with the balancer to identify the parts to be replaced.

Always comply with the safety precautions and instructions described at the beginning of this manual.

### Operational Check

1. Attach the power cord. Switch on the balancer.
2. Press Mode several times. The Weight Mode indicators should light corresponding to each weight mode selected. Return to the Normal weight mode.
3. Press Fine to set Fine Mode. The Fine indicator should light. The Auto indicator should also be displayed.

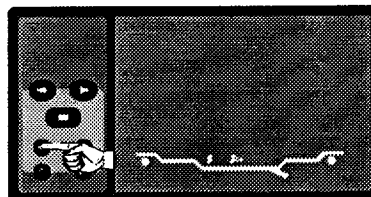
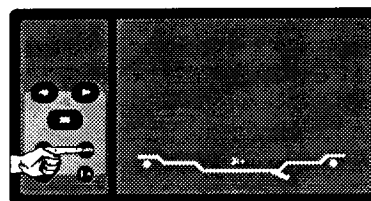
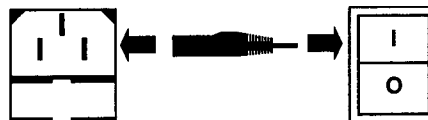

8. Remove the 3-ounce (100-gram) weight and verify that the wheel is balanced in Fine Mode.

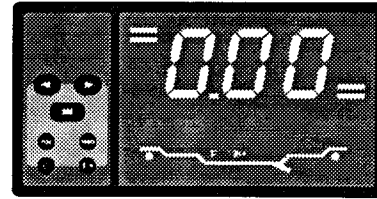

9. Rotate the wheel 180° in relation to the mounting flange and re-spin. The sum of the inner and outer readings should be a maximum of 0.50 ounces (15 grams) for a 14" or smaller wheel. If the sum is higher, make sure the wheel is properly centered when tightening the hub nut. Clean the mounting surface, spindle, cones and wheel, and then repeat the check. If the new sum is also too high, repeat the check with a new wheel.

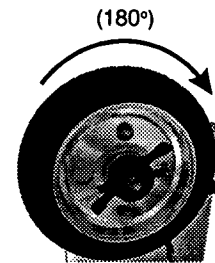

If the balancer fails any of the above steps, contact your service representative for assistance in correcting the problem.

8. Remove the 3-ounce (100-gram) weight and verify that the wheel is balanced in Fine Mode.

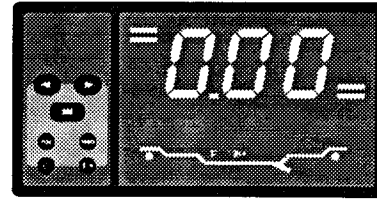

9. Rotate the wheel 180° in relation to the mounting flange and re-spin. The sum of the inner and outer readings should be a maximum of 0.50 ounces (15 grams) for a 14" or smaller wheel. If the sum is higher, make sure the wheel is properly centered when tightening the hub nut. Clean the mounting surface, spindle, cones and wheel, and then repeat the check. If the new sum is also too high, repeat the check with a new wheel.

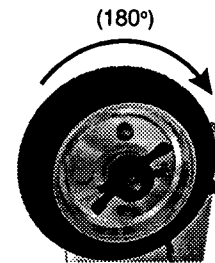

If the balancer fails any of the above steps, contact your service representative for assistance in correcting the problem.



## Troubleshooting Guide

The following tips will help to identify and correct problems which may be encountered when using the wheel balancer.

### A. No indicators on the display panel are lit.

There may be no power supplied to the balancer. A fuse may be blown or a cable may be loose.

Ensure the power cord is inserted properly in the mains inlet at the rear of the balancer unit.

Remove the power cord. Check the fuse in the plug or in the wall outlet. Replace if necessary.

Replace the 10A fuse contained in the small tray of the mains inlet. The inner fuse is in-line; the outer fuse is a spare.

Unplug the power cord. Remove the weight tray and check all cable connections.

### B. Display appears to freeze or lock up.

The power to the balancer may have been interrupted, or the balancer may have been left with the Optimatch programme active.

Turn off the power, wait a few seconds, and turn on the power again.

If the Optimatch programme is active, pressing Fine on the input panel will exit to normal operation.

### C. Balancing results are inconsistent.

The balancer may not be resting on a solid and level surface, the mounting accessories or stub shaft may be worn or damaged, or the electronics assembly or sensors may have been replaced.

Ensure that the balancer is fixed in position.

Inspect the mounting accessories and stub shaft; replace if necessary.

Perform the Weight Calibration procedure.

Move the balancer to a new location and try again (note that the balancer is heavy - do not move the balancer without assistance).

**D. E11 or E21 is displayed during operation.**

The motor may be spinning the shaft up to speed too fast. Alternatively, the wheel may be slowing or stopping during the cycle. This may be due to a) no wheel or a light wheel rim being mounted; b) the wheel slipping on the shaft when the motor accelerates the shaft.

Ensure that the wheel is mounted properly and that the Hub Nut is securely tightening the wheel against the flange; the wheel must not slip on the shaft.

Check that wheel movement is not being impeded.

When only a wheel rim is mounted, the rim may be too light to maintain speed; try spinning the rim a little faster, using a hand-spin.

If the wheel is very heavy and the motor cannot accelerate it to measuring speed, leave the frame raised and try spinning the wheel by hand.

**E. E12 is displayed during operation.**

The frame has been raised before the balancing cycle is completed.

The frame is lowered to start the motor. The balancer will beep once when the wheel reaches measuring speed. Always wait until the end of the balancing cycle (the balancer beeps for the second time and the brake is engaged automatically) before raising the frame again.

**F. E14 is displayed during operation.**

The balancer is in Automatic mode and the frame hasn't been lowered to scan the wheel. The most probable cause is hand-spinning a wheel in this mode.

Repeat the balancing procedure, ensuring a complete scan of the wheel with the frame.



**G. E23 is displayed during operation.**

In hand-spin mode, the wheel has been spun in the wrong direction (anti-clockwise when facing the outer rim).

Respin the wheel, spinning it in the correct direction (clockwise when facing the outer rim).

**H. E24 is displayed during operation.**

The motor is on and there is no movement for more than 2 seconds. This may be caused by grease gathering on the drive wheel, the brake sticking in the engaged position, or the shaft being impeded.

Switch off the balancer and unplug the power cord from the wall outlet. Remove the weight tray. Check for grease on the surface of the drive wheel. If necessary clean surfaces with solvent.

With the power off and the weight tray removed, check that the brake mechanism is not sticking.

Press Auto to change to manual mode and hand-spin the wheel.

**I. E25 is displayed during operation.**

The motor is unable to spin the wheel up to measuring speed within approximately 20 seconds, because the wheel is too heavy or because the mains supply is being interrupted.

Ensure that the wheel is mounted properly and that the Hub Nut is securely tightening the wheel against the flange; the wheel must not slip on the shaft.

Check that wheel movement is not being impeded. When only a wheel rim is mounted, the rim may be too light to maintain speed; try spinning the rim a little faster, using a hand-spin.

If the wheel is very heavy and the motor cannot accelerate it to measuring speed, leave the frame raised and try spinning the wheel by hand.



**J. E26 E27 or E28 is displayed during operation.**

The dimensions of the wheels are outside the specifications for use in Automatic mode.

Compare wheel specifications to those in the Technical Specifications section at the back of the manual.

Press Auto to change to manual mode and hand-spin the wheel.

**K. E15 E16 E17 E18 E19 or E29 is displayed during operation.**

In Automatic mode, there is a problem measuring the wheel.

Compare wheel specifications to those in the Technical Specifications section at the back of the manual.

Press Auto to change to manual mode and hand-spin the wheel.

**L. Balancer beeps continuously.**

The wheel has been spun too fast by hand and is spinning above the measurement speed range, or there may be a fault in the electronics assembly.

Wait until the wheel slows to a speed within the required range or carefully slow the wheel. The balancer will no longer beep when the wheel spins at the correct measuring speed, and will continue with the balancing cycle.

If the balancer continues to beep even when the wheel is slowed or stopped, then the balancer should be switched off. Wait a few seconds and then turn on the power again.

**M. The decimal point is constantly displayed.**

The balancer is set to display weight units in ounces, or the display electronics are faulty.

To change weight units, press Left Arrow and Match on the input panel. Hold both pressed for a second. The balancer will beep and the decimal point will be turned off.

If this does not work, the electronics assembly should be replaced.



**J. E26 E27 or E28 is displayed during operation.**

The dimensions of the wheels are outside the specifications for use in Automatic mode.

Compare wheel specifications to those in the Technical Specifications section at the back of the manual.

Press Auto to change to manual mode and hand-spin the wheel.

**K. E15 E16 E17 E18 E19 or E29 is displayed during operation.**

In Automatic mode, there is a problem measuring the wheel.

Compare wheel specifications to those in the Technical Specifications section at the back of the manual.

Press Auto to change to manual mode and hand-spin the wheel.

**L. Balancer beeps continuously.**

The wheel has been spun too fast by hand and is spinning above the measurement speed range, or there may be a fault in the electronics assembly.

Wait until the wheel slows to a speed within the required range or carefully slow the wheel. The balancer will no longer beep when the wheel spins at the correct measuring speed, and will continue with the balancing cycle.

If the balancer continues to beep even when the wheel is slowed or stopped, then the balancer should be switched off. Wait a few seconds and then turn on the power again.

**M. The decimal point is constantly displayed.**

The balancer is set to display weight units in ounces, or the display electronics are faulty.

To change weight units, press Left Arrow and Match on the input panel. Hold both pressed for a second. The balancer will beep and the decimal point will be turned off.

If this does not work, the electronics assembly should be replaced.



## TECHNICAL SPECIFICATIONS

### Maximum tire diameter

- Automatic 40" (1016mm)
- Non-Automatic (Motor-spin) 40" (1016mm)
- Non-Automatic (Hand-spin) 44" (1118mm)

Maximum tire width 19" (483mm)

### Maximum rim diameter

- Automatic 17" (432mm)
- Non-Automatic (Motor-spin) 24" (607mm)
- Non-Automatic (Hand-spin) 24" (607mm)

Maximum rim width 14" (355mm)

Maximum wheel weight 154lbs (70kg)

Power supply 110Vac/60Hz

Balancer weight 242lbs (110kg)

Shipping weight 300lbs (136kg)

### Balancer dimensions-

Height	59" (1500mm)
Floor area: Length	24" (600mm)
Width	24" (600mm)

### Shipping dimensions-

Height	39" (970mm)
Length	47" (1180mm)
Width	30" (750mm)

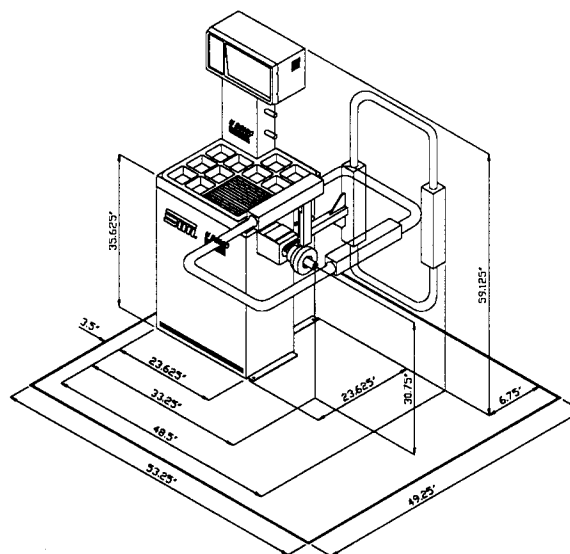

**The information and specifications in this manual are based on the latest information available at the time of publication. The product manufacturer reserves the right to change the specifications at any time without notice.**

This product is protected under the following Patents, and Patent Applications Pending:

U.S.A.	4,435,982 4,489,608 4,507,964 4,741,211 5,189,912 5,419,193
U.K.	GB 2 131 561 B GB 2 153 095 B
Canada	1,217,661 1,230,758
France	2 536 857 2 558 591
Canada	1,217,661 1,230,758
Japan	733740 06-065975 07-015423
Australia	574053 575371 625,780 661,552
Europe	0,358,496 (DE P689 21 271.2-08, GB, FR, ES, IT, NL)
Germany	DE 35 01 577 C2
Ireland	S 58405
Italy	1,182,123

---

**NOTES**





**SUN ELECTRIC**  
One Sun Parkway  
Crystal Lake, IL., 60014

P/N 8868 Rev A.  
Printed in Ireland.  
ECO 3426 - 5/96.

"FOR REFERENCE ONLY"